

CHAMBERLAIN®

ELITE™



EL25 Installation Manual

Telephone entry/access control system with a 25 directory code capacity

Table of Contents

Wire Type

Wire Connections to EL25 (Factory Settings for Relays)	2
Wire Specs and Run Distances	3
Power Wire Specs and Run Distances	3

Mounting the Unit

Installation of the EL25	4-5
Rotating the Keypad for Vertical Mounting	5

Phone Lines

Wiring 1 EL25 to the Telco Line (Alarm System Position)	6
Wiring Multiple EL25 Units to the Telco Line	7
Wiring with No Telco Line	8
Wiring to Dedicated Telco line	9
Wiring to an Internal Phone System	10

External Devices

Wiring a Door Strike Lock	11
Wiring a Maglock	11
Wiring a Gate Operator	12
Wiring a Key Switch/PIR/REX	12
Wiring a Door Sensing Device	13
Wiring the AutoCall Feature	13
Wiring a Radio Frequency Module (RF) (Optional RF Module(s) Needed)	14
Wiegand Card Reader / Keypad (Optional Wiegand Module(s) Needed)	14
Wiring a Postal Lock Switch	15
Wiring an Internal Camera (CCTV) (Optional CCTV Module Needed)	15

Grounding the Unit

Grounding the EL25	16
--------------------	----

Power

Wiring Power to the EL25 and Powering Up the Unit	17-18
---	-------

Programming Adjustments

Adjust Microphone / Speaker Volume	19
“Multiple Unit” Set-Up	19

Troubleshooting

Troubleshooting	20
-----------------	----

Repair Parts

EL25 Repair Parts	21
-------------------	----

“Your” Set-Up

“Your” System Diagram and Wiring Configuration	22-23
--	-------

Accessories

Accessories	24
-------------	----

FCC and DOC and Appendix

FCC and DOC Requirements	25
Appendix	26-27

Wire Connections to EL25

Back Mounting Plate

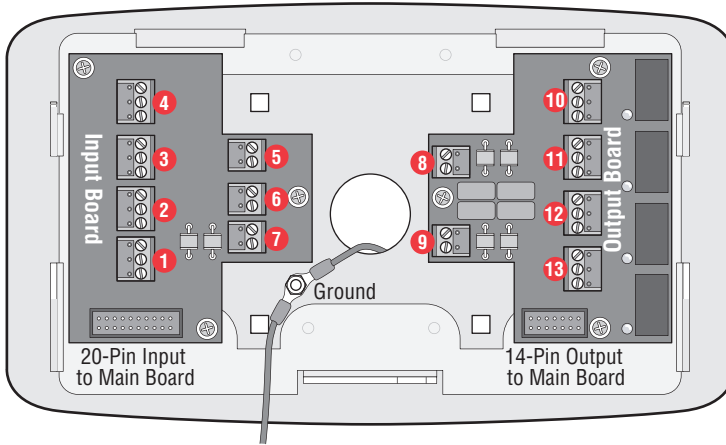

Input Board Connections

- 1 Door 1 Exit Request and Door Status
- 2 Door 2 Exit Request and Door Status
- 3 Door 3 Exit Request and Door Status
- 4 Door 4 Exit Request and Door Status
- 5 Postal Lock Input
- 6 AutoCall Input
- 7 Power 12 VAC Input

Output Board Connections

- 8 Resident Tip / Ring
- 9 Telco Tip / Ring
- 10 Relay 4, NO,NC,COM
- 11 Relay 3, NO,NC,COM
- 12 Relay 2, NO,NC,COM
- 13 Relay 1, NO,NC,COM

Note: All relays are factory set to "Strike" and "10 sec."

Do Not overload the removable terminal block connectors. One wire per hole.

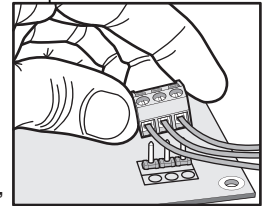

Optional Modules

Caution! A Static Discharge can Damage Circuit Boards

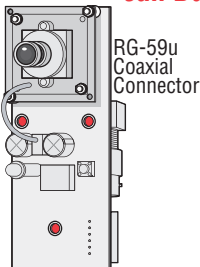

Optional CCTV Module (Page 15)
(Replaces Call Button Board)



Optional RF Module (Page 14)
(Fits in J400 and/or J407)

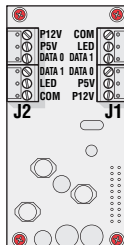

Optional Wiegand Module (Page 14)
(Fits in J400 and/or J407)

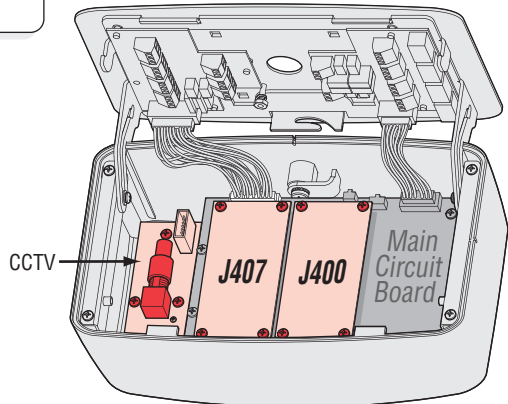

Optional Module Mounting Positions

Wire Specs and Run Distances

Use this chart to pull wires in preparation of your installation:

Description of Wire Run	Wire Specification	Maximum Distance	Recommended Wire Type	Page
Residence and Telco <i>Phone Lines</i>	2 Twisted Pairs 18-24 AWG Shielded	5000 feet	Belden #7838A	6-10
<i>Door Strike</i>	2 -Conductor 18-22 AWG Shielded		Alpha #1292C	11
<i>Magnetic Lock</i>	2 -Conductor 18-22 AWG Shielded		Alpha #1292C	11
Dry Contact Closure (Most <i>Gate Operators</i>)	2 -Conductor 18-24 AWG Shielded		Alpha #1292C	12
<i>Exit Request</i> (REX) / <i>Auxiliary Open</i> Devices	2 -Conductor 18-24 AWG Shielded		Alpha #1292C	12
<i>AutoCall</i>	2 -Conductor 18-24 AWG Shielded		Alpha #1292C	13
<i>Door Status Sensor</i>	2 -Conductor 18-24 AWG Shielded		Alpha #1292C	13
Barium Ferrite and <i>Wiegand Readers</i>	5 -Conductor 18-24 AWG Shielded	500 feet	Alpha #1295C	14
<i>Proximity Readers</i>	5 -Conductor 22 AWG Shielded	500 feet	Alpha #1295C	14
<i>Radio Frequency Module (RF)</i>	RG-6 Coaxial 75 ohm	100 feet	Belden BRG6 Cable	14
<i>Postal Lock</i>	2 -Conductor 18-24 AWG Shielded		Alpha #1292C	15
<i>CCTV Camera</i> (Optional)	Single Conductor RG-59u Coaxial	1000 feet (Monitor with a .25 volt p-p composite signal sensitivity)	Belden #9240 BNC Connectors (Amphenol #31-71008 or equivalent)	15
<i>Grounding</i> the Chassis	12 AWG Copper	12 feet	Belden #9912	16

Note: *Use metal conduit* - run wires in metal conduit instead of PVC pipe. Wires run in PVC conduit may experience interference. Metal conduits also add extra protection against lightning strikes.

Never run *Data wires* and *High Voltage wires* in the **same** conduit. The high voltage wires may interfere with the data wires, possibly causing the system to malfunction.

Power Wire Specs and Run Distances

Distance	12 VAC Power (Included) 2 -Conductor Shielded	12 VDC Power (Not Provided) 2 -Conductor Shielded
Under 30 Feet	14 AWG	16 AWG
30 - 75 Feet	14 AWG	14 AWG
75 - 250 Feet	14 AWG	N/A

Always provide power from a dedicated source. Plug provided transformer into an outlet wired to its **own** 10 Amp minimum circuit breaker. This will prevent two problems:

- ① Other equipment cannot introduce spikes, noise, surges, or dips into the power circuit that will affect the system.
- ② The system's operation will not be affected if any other equipment develops a short circuit across the power line.

Installation of EL25

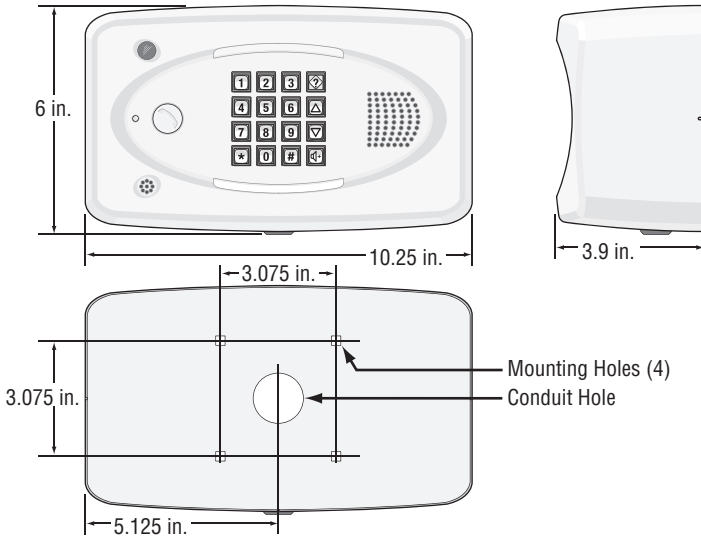

Vertical Mounting Position
with rotated keypad (see next page)

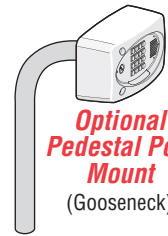

Optional Pedestal Post Mount
(Gooseneck)

Caution! A Static Discharge can Damage Circuit Boards

① Unlock Unit

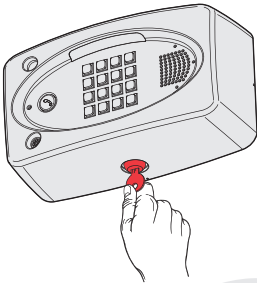

② Carefully Lift Cover Up then Slide Out on Hinges

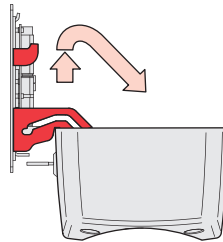

③ Unplug the 2 Main Harnesses

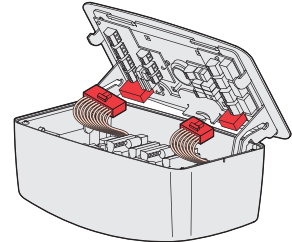

④ Line up Notch with Screw and Push Hinge Out

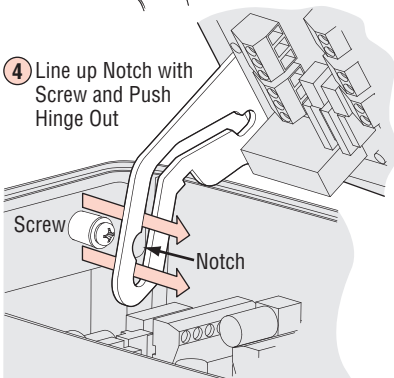

⑤ Remove Back Mounting Plate from Cover

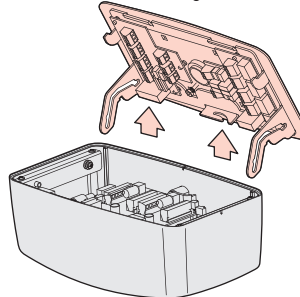

Continued →

Installation of EL25

- 6 Secure Back Mounting Plate to Surface or Pedestal Post in 4 Places.
- 7 Run **All** Wires Through Conduit Hole for Connections.

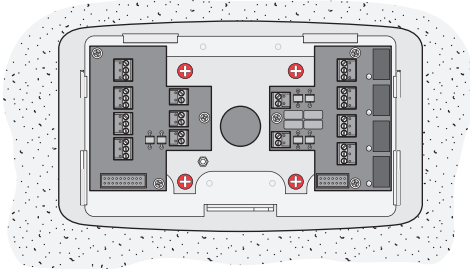

EL25 MUST
be Properly
Grounded!
See Page 16.

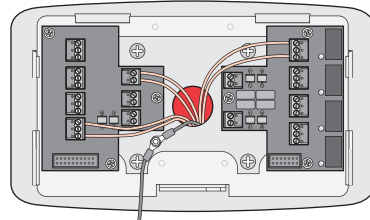

Keep Wires Neat! Use zip ties if necessary.

- 8 Reverse the Sequence to Reassemble Unit.

DO NOT Pinch Wires when Closing and Locking the Unit!

Do Not overload the removable terminal block connectors. One wire per hole.

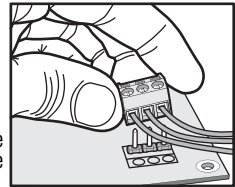

Rotating the Keypad for Vertical Mounting

Caution! A Static Discharge can Damage Circuit Boards

- 1 Disconnect all Plugs from Main Circuit Board and Remove Board. (4 Screws)
- 2 Remove Bracket. (4 Screws)
- 3 Rotate Keypad 90 Degrees Clockwise.
- 4 Reverse the Sequence to Reassemble Unit.

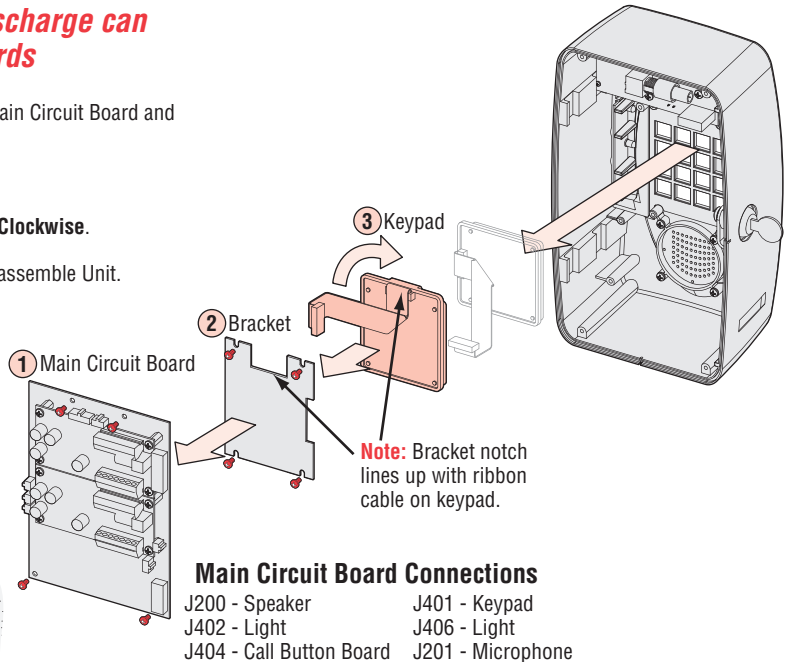

Wiring 1 EL25 to Telco Line

The bypass board allows the EL25 to be disconnected without interrupting normal telephone operation.

- When the EL25 unit is **in use**, the bypass switch must be set to the **operate** position.
- When the EL25 unit is **disconnected**, the bypass switch must be set to the **bypass** position.

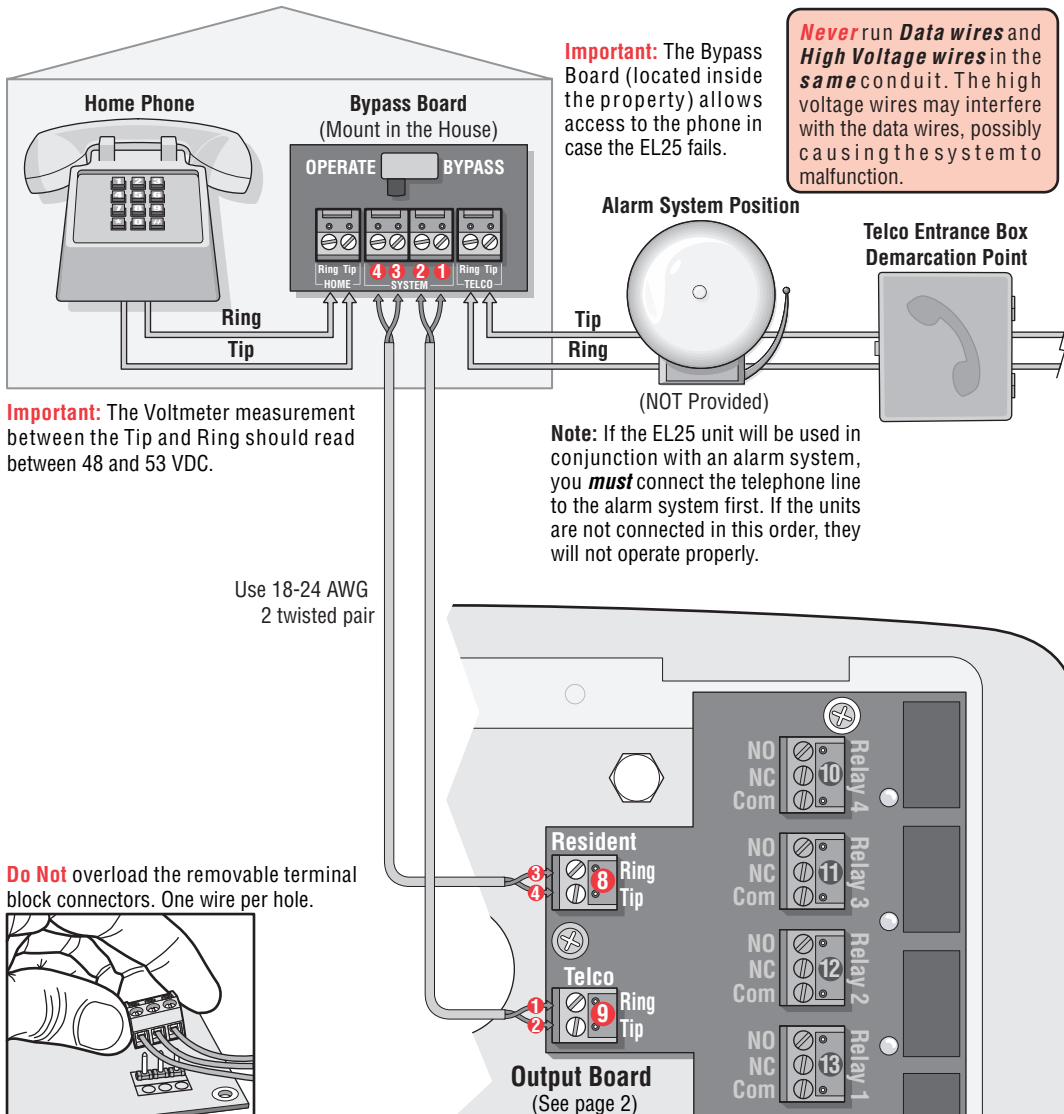

Wiring Multiple EL25 Units to Telco Line

Up to **7 EL25s** can share the same phone line. The bypass boards allow the EL25 units to be disconnected without interrupting normal telephone operation.

- When the EL25 units are **in use**, the bypass switches must be set to the **operate** position.
- When the EL25 units are **disconnected**, the bypass switches must be set to the **bypass** position.

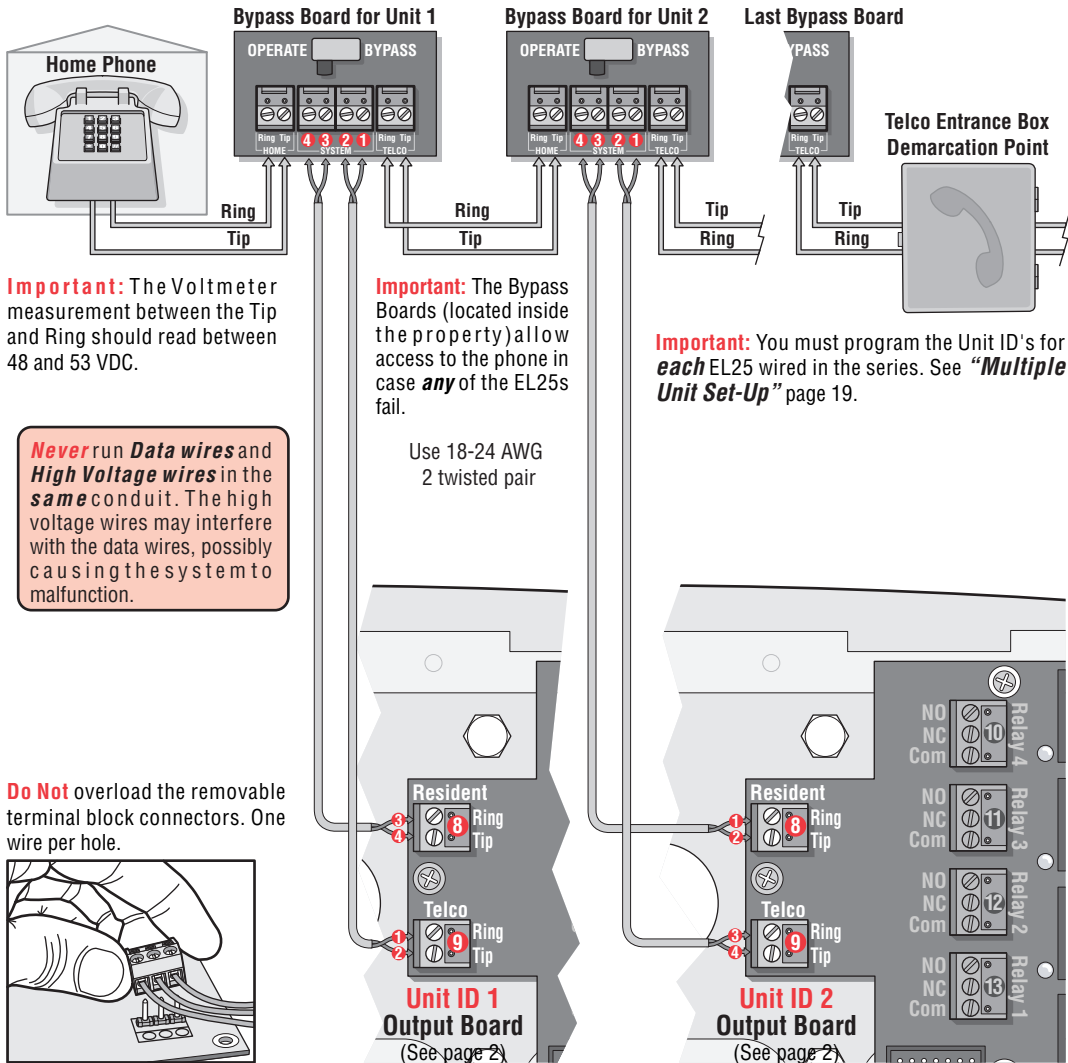

No Telco Line

The EL25 can be a stand alone system that allows communication between the unit and a resident's phones.

Single EL25

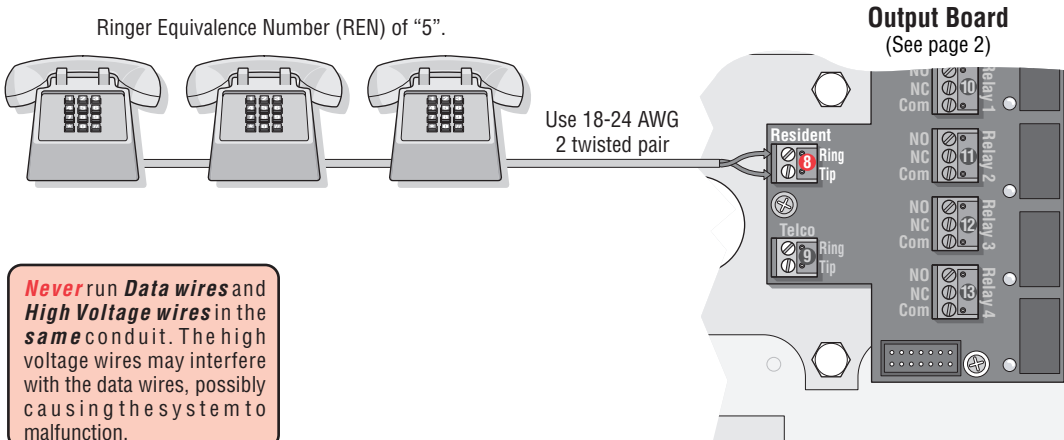

Multiple EL25s (Up to 7)

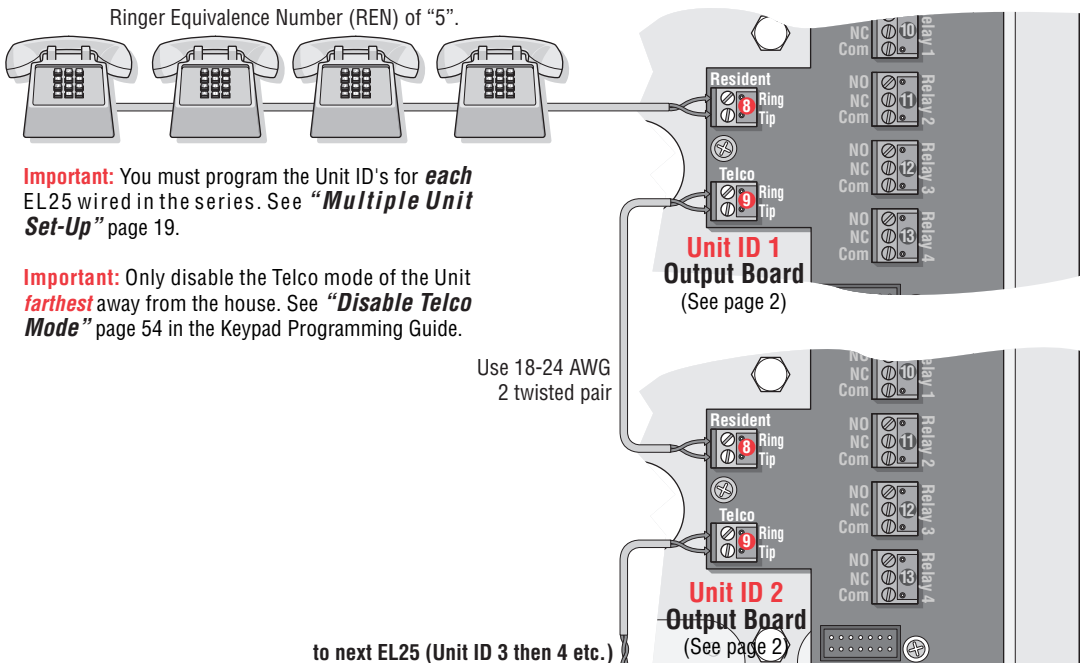

Dedicated Telco Line

Single EL25

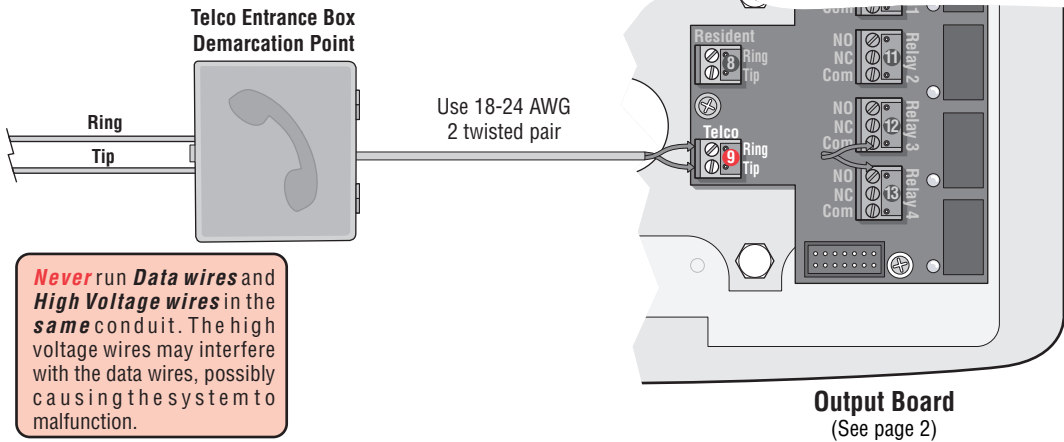

Multiple EL25s (Up to 7)

Important: You must program the Unit ID's for **each** EL25 wired in the series. See **"Multiple Unit Set-Up"** page 19.

to next EL25 (Unit ID 5 then 4 etc.
Unit ID 1 is farthest away from Telco Box)

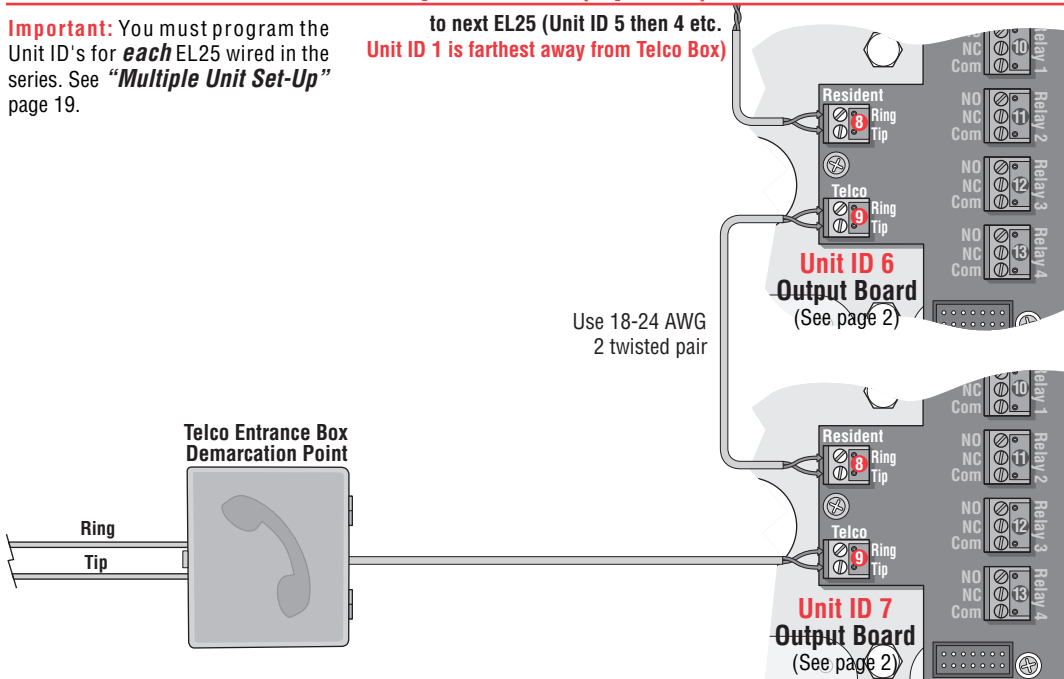

Dedicated Telco Line

Internal Phone System

The EL25 can be wired to any **Analog Trunk Input** in a internal home phone system.

Single EL25

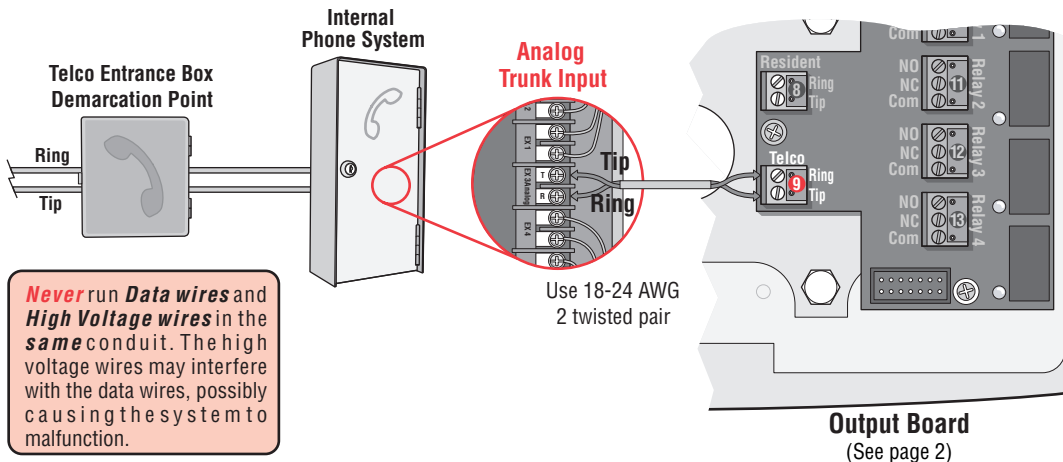

Multiple EL25s (Up to 7)

Important: You must program the Unit ID's for **each** EL25 wired in the series. See "**Multiple Unit Set-Up**" page 19.

to next EL25 (Unit ID 5 then 4 etc.)
Unit ID 1 is farthest away from Telco Box)

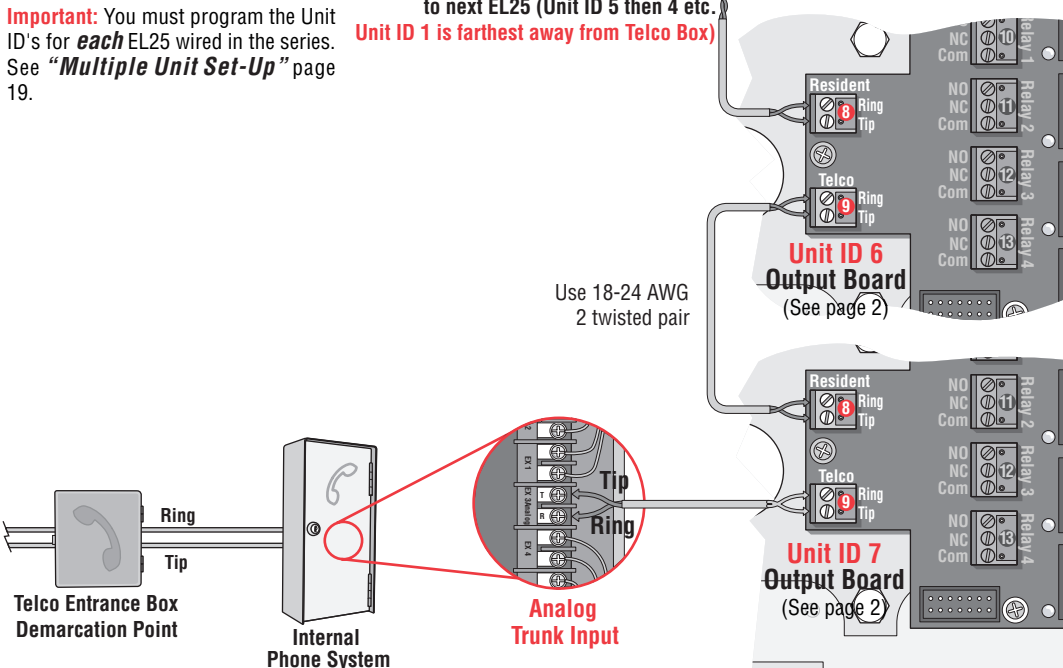

Wiring a Door Strike Lock

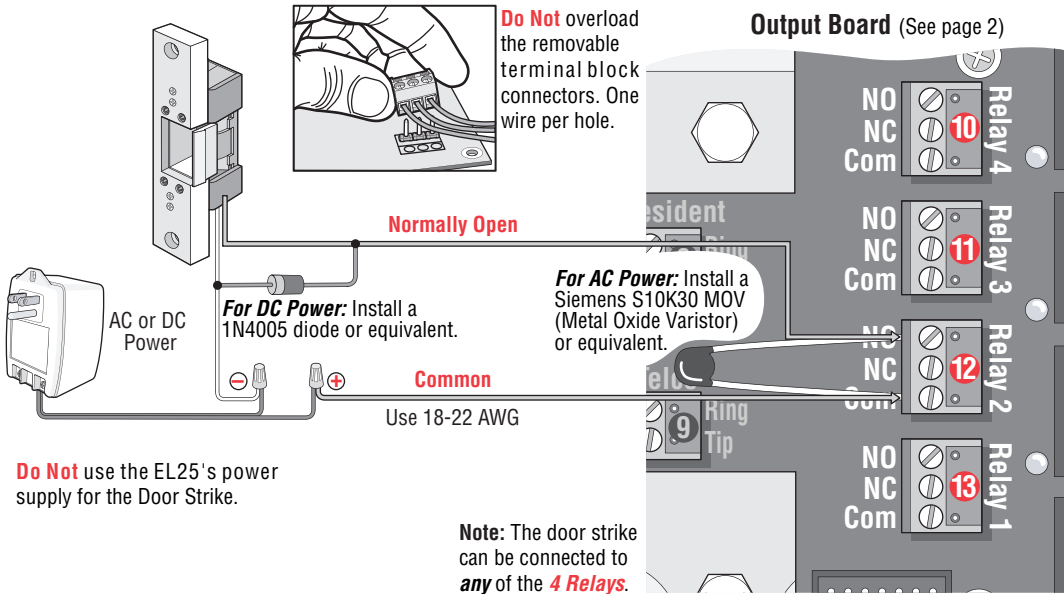

Wiring a Maglock

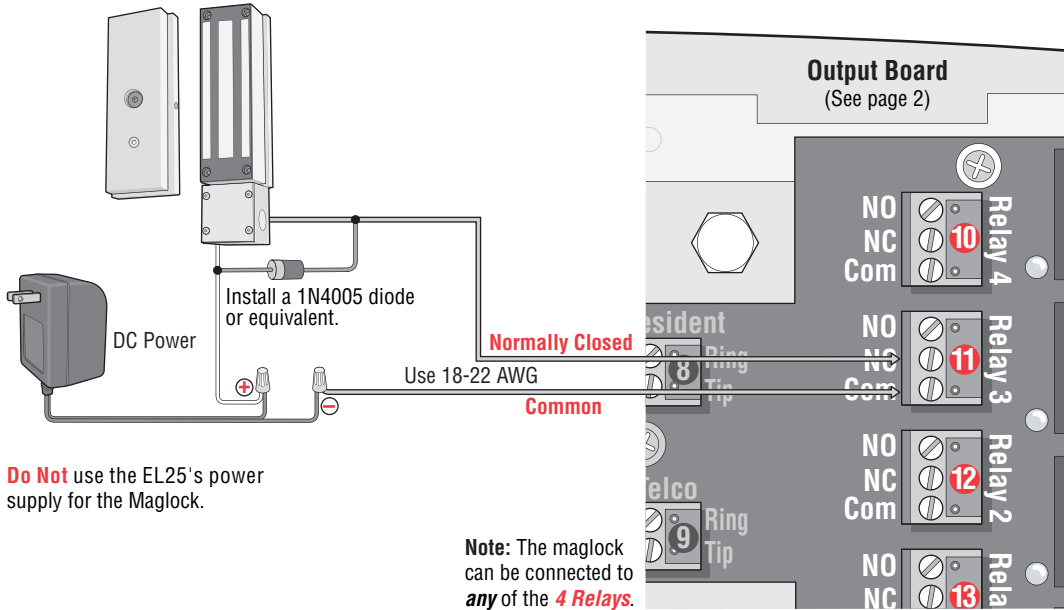

Door Strike Lock / Maglock

Wiring a Gate Operator

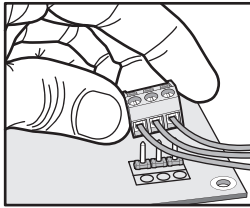

Do Not overload the removable terminal block connectors. One wire per hole.



Normally Open

Common

Use 18-24 AWG

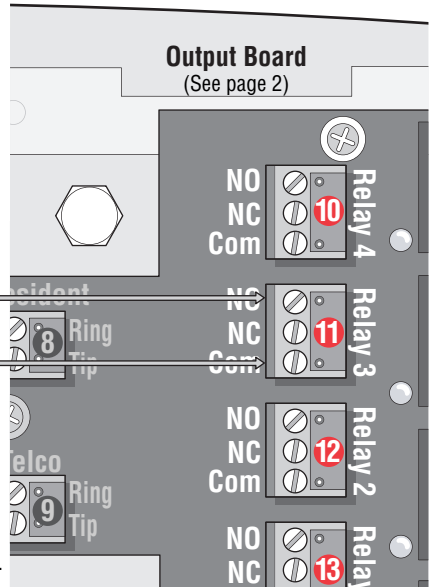

Note: The gate operator can be connected to **any** of the **4 Relays**.

Wiring a Key Switch/PIR/REX

Any auxiliary opening device such as a key switch or PIR (Passive Infrared Device), or an exit request button (REX) that provides **contact closure** can be hooked up to the Door Input terminals.

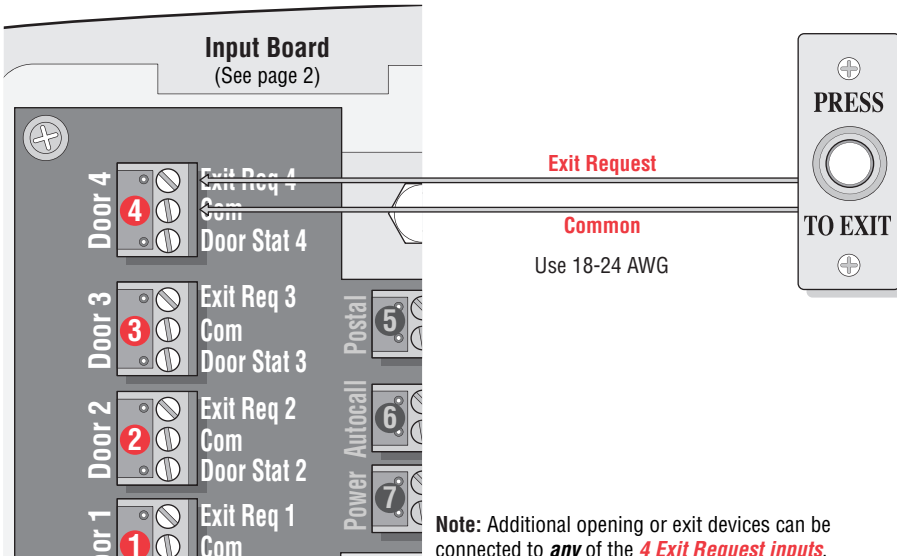

Exit Request

Common

Use 18-24 AWG

Note: Additional opening or exit devices can be connected to **any** of the **4 Exit Request inputs**.

Wiring a Door Sensing Device

The EL25 can monitor the position of up to **four doors/gates** and may react to a change in their status with one of the relays (not set as a control relay). For example, if a door is pried open or is held open after its relay deactivates, the unit will record the breach in its transactions and can perform the following actions:

- Call the main residence phone and report the status of the door.
- Energize a relay to activate an alarm device such as a siren, light, or CCTV camera.
- Main use is to terminate strike time early.

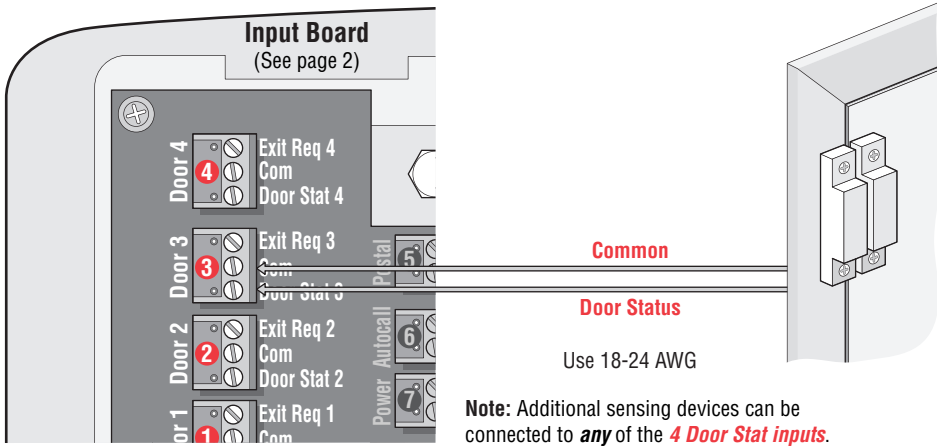

Wiring the AutoCall Feature

Using the AutoCall feature, the EL25 will automatically call the main residence phone when a driveway sensor is **activated** (any device that provides a **contact closure**). For example, when a visitor drives over a **loop sensor** that is connected to the AutoCall feature, the EL25 will call the main residence phone automatically so the visitor can speak to the resident **without** pressing the call button on the unit.

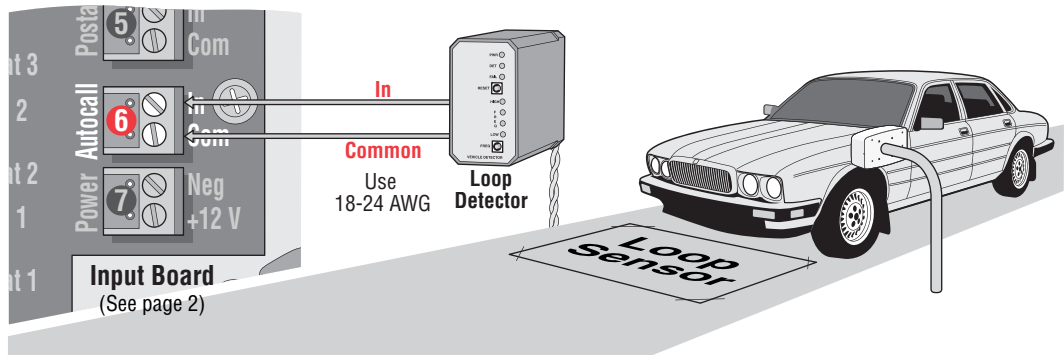

Wiring a Radio Frequency Module

An optional **radio frequency module** and a remote antenna can be installed if **the residents will access a controlled area with a transmitter**. Refer to instructions supplied with the optional **RF Module** for more information.

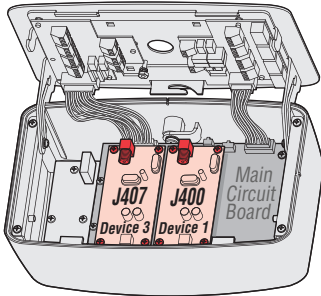

RF Module(s) will fit in **J400 as Device 1** and/or **J407 as Device 3**.
(4 Mounting Screws per Board)

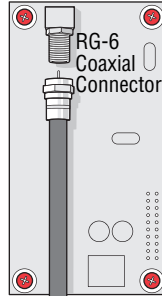

1 RF Module Kit
Part # RFMODKT

RG-6 Coaxial Cable
100 Feet Maximum

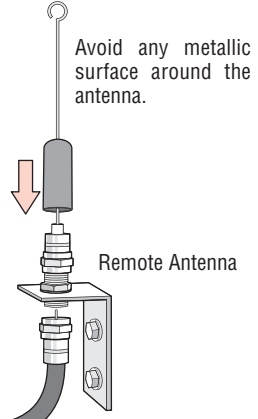

Wiegand Card Reader / Keypad

Wiegand card readers and keypads can be connected to either of **2 optional wiegand modules** that can be placed in the EL25. **Each wiegand module supports two card readers/keypads**. Some wiegand card reader/keypads have a sixth blue wire. **Do Not** connect this blue wire to the EL25. Insulate this wire from the unit to prevent a short (Refer to instructions supplied with your wiegand device for more information).

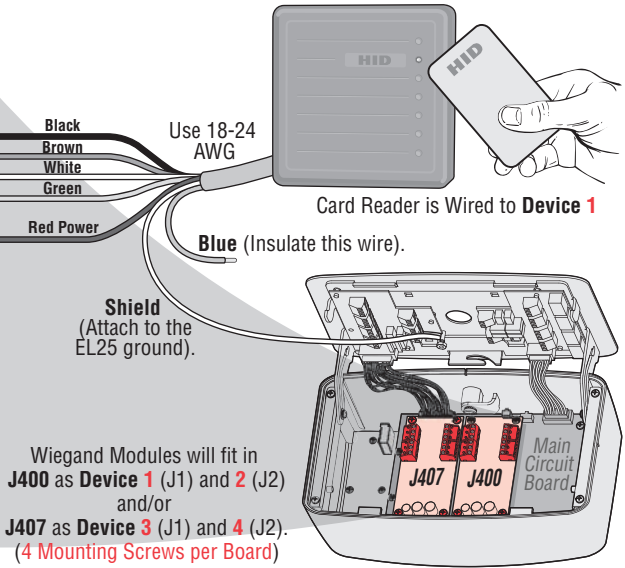
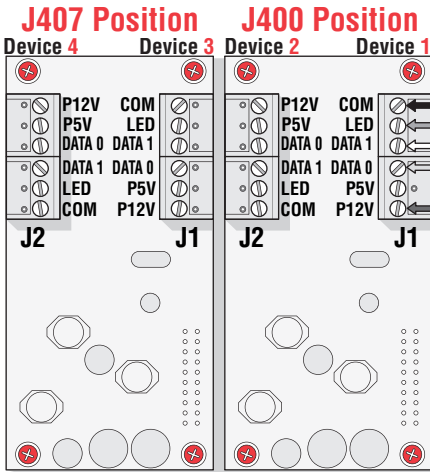

1 Wiegand Module Kit
Part # WOMODKT

Wiring a Postal Lock Switch

The **Post Office requires** installation of a postal lock **if postal carriers do not have access to a controlled area**. Contact the local post office and arrange for them to install the postal lock while you are on site. The postal lock requires a switch to activate one of the four relays (Configurable with programming number **69**, page 58 in the Keypad Programming Manual).

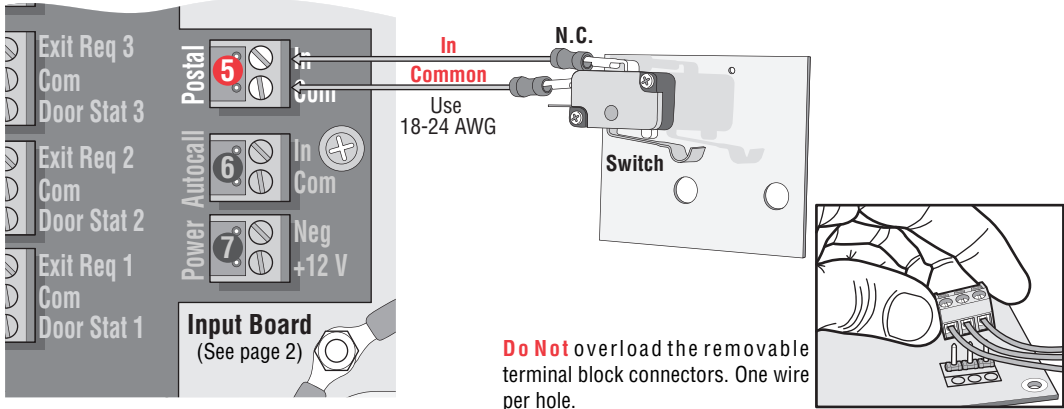

Wiring an Internal Camera (CCTV)

An **Optional** CCTV (Close Circuit Television) Camera can be installed **inside** the EL25 unit replacing the Call Button Board, refer to instructions supplied with the Camera kit for more information.

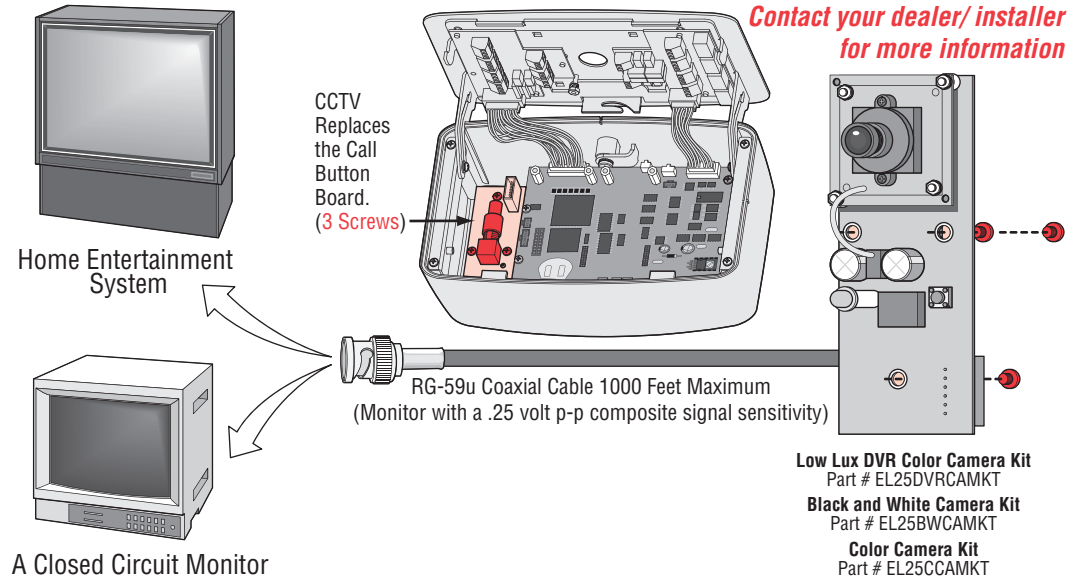

Postal Lock Switch / CCTV Camera

Grounding the EL25

Ensure that the system is grounded properly. The EL25 contains a number of static sensitive components that can be **damaged** by static discharge.

Important: An Earth Ground Rod is **Strongly Recommended** and should be no further than 12 ft from the unit and use a minimum of 12 gauge wire in most cases. The type and length of earth ground rods vary by region. **Contact the building inspector's office in the municipality where you plan to install the unit for correct grounding materials and installation procedures.**

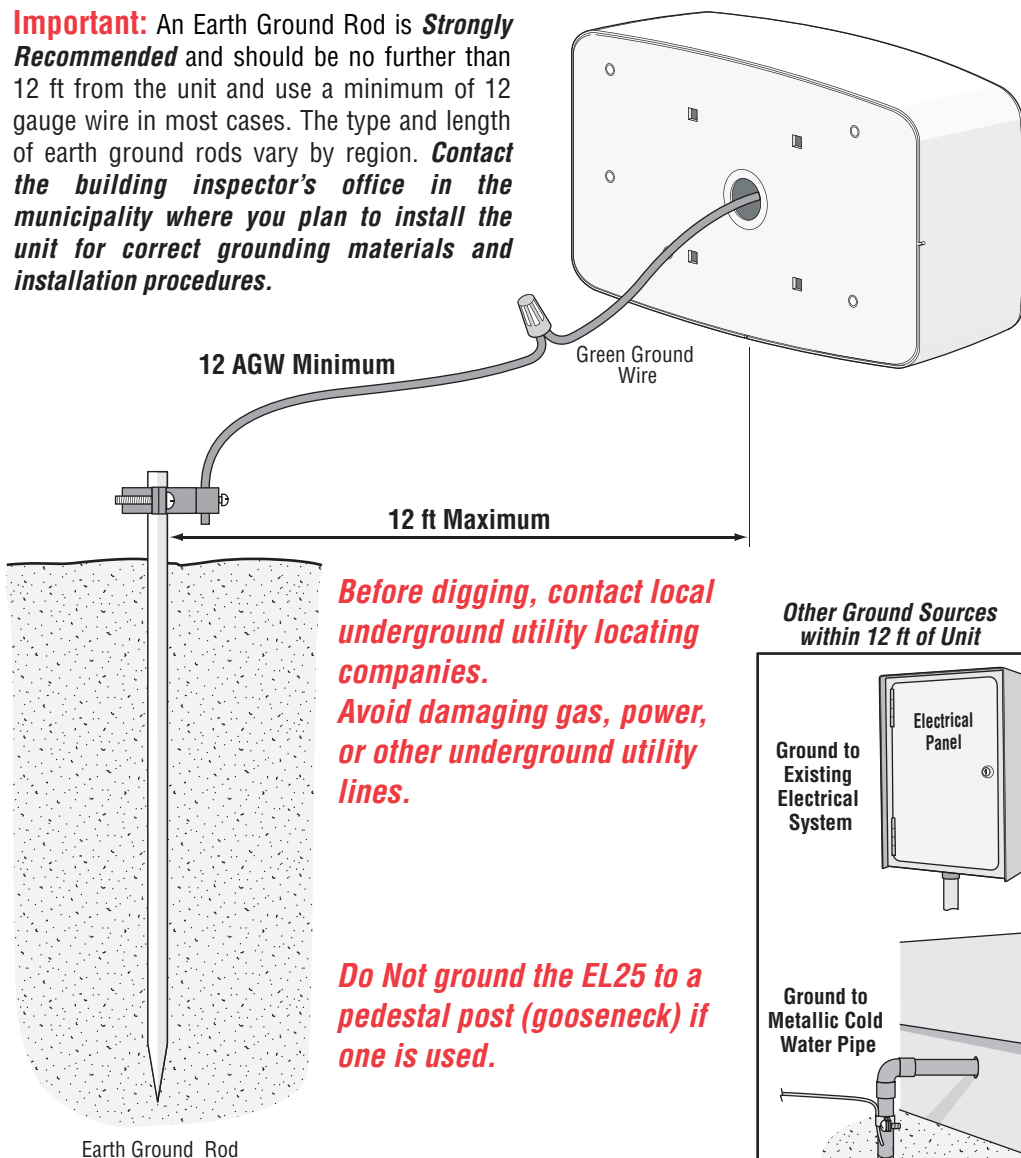

Wiring Power to the EL25

The 110 VAC outlet must be **dedicated** to the EL25 **ONLY**. This outlet should be wired back to its **own** 10 Amp minimum circuit breaker. This will prevent two problems:

- ① Other equipment cannot introduce spikes, noise, surges, or dips into the power circuit.
- ② The system's operation will not be affected if any other equipment develops a short circuit across the power line.

Connect the transformer into a 110 VAC outlet **after all** connections have been made. **Any other type of outlet will cause damage to the system.**

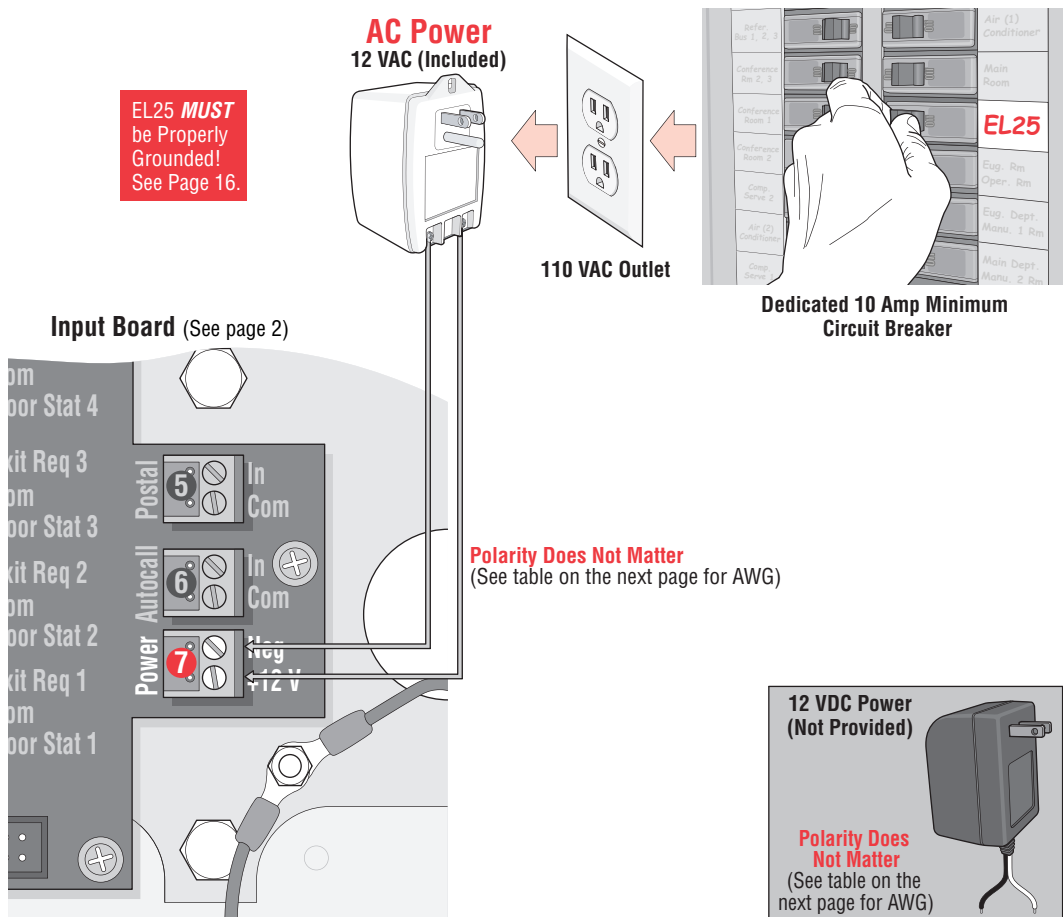

Wiring Power to the EL25 (con't)

Power Wire Specifications and Run Distances

Distance	12 VAC Power (Included) 2 -Conductor Shielded	12 VDC Power (Not Provided) 2 -Conductor Shielded
Under 30 Feet	14 AWG	16 AWG
30 - 75 Feet	14 AWG	14 AWG
75 - 250 Feet	14 AWG	N/A

Caution: Not responsible for conflicts between the information listed in the above table and the requirements of your local building codes. The information is for suggested use only. Check your local codes before installation.

Powering Up and Checking the LEDs

Plug the transformer into the 110 VAC outlet. Check the **SYS PWR** LEDs on the Main board.

- ON LED** – Board has Power.
- LO LED** – Power is Too Low.
- HI LED** – Power is Too High.

If the **LO** or **HI** LEDs are lit, press the **PWR MON RST** (Power Monitor Reset) button.

If the **LO** or **HI** LED is still lit, check the power connections, wiring, and transformer.

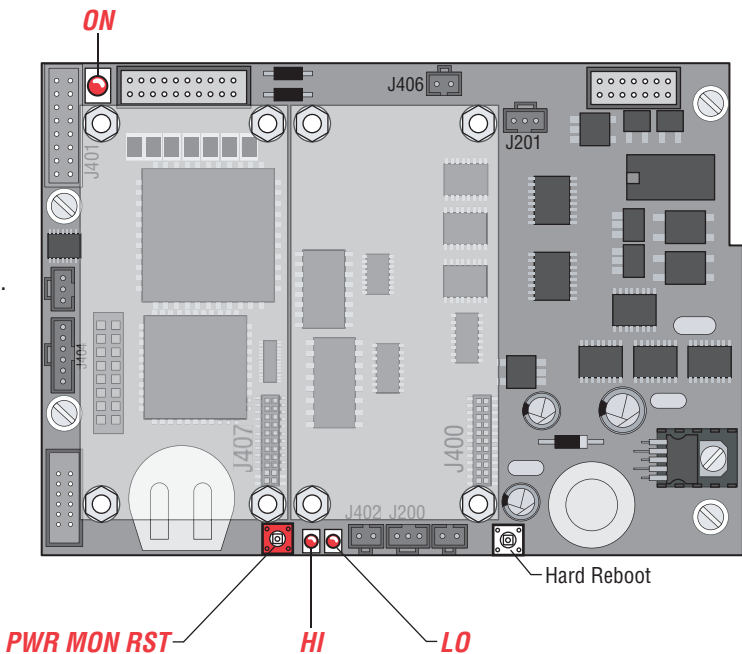

Adjust Microphone / Speaker Volume

Adjust Speaker Volume: 18

Allows the visitor to hear the resident at the unit. **Factory Setting for the Speaker is “5”.**

Enter Programming Mode	Factory Password	Programming Sequence	Exit Programming Mode
* * * 0 0 0 0 0 0	2 Short Beeps Will be Heard	1 8 # Set Speaker Level (0=Mute, 1=Low...10=High)	# 0 # 3 Short Beeps Will be Heard

Note: The visitor can adjust the speaker volume on unit with this key. Unit will return to programmed volume setting when call is complete.

Adjust Microphone Volume: 19

Allows the resident to hear the visitor at the unit. **Factory Setting for the Microphone is “5”.**

Enter Programming Mode	Factory Password	Programming Sequence	Exit Programming Mode
* * * 0 0 0 0 0 0	2 Short Beeps Will be Heard	1 9 # Set Microphone Level (0=Mute, 1=Low...10=High)	# 0 # 3 Short Beeps Will be Heard

For more information refer to the Keypad Programming Manual

If you make an error during the programming sequence, press the asterisk key (*) to start the programming sequence again.

“Multiple Unit” Set-Up

Up to seven (7) EL25s can be installed on a single telephone line. **Each** unit must have a **“Unique Unit ID”** number and the **“Number of Units in Chain”** assigned to it. Unit ID #1 is always connected to the residence.

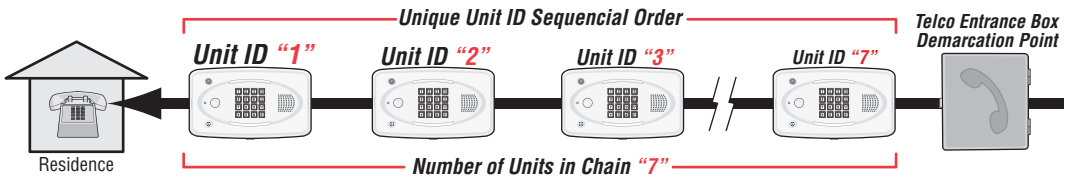

Set the Unit's ID Number and Number of Units in Chain: 2

This must be performed on **each** unit in the chain. **Factory Setting is “Unit ID 1” and “Number of Units in Chain 1”.**

Enter Programming Mode	Factory Password	Programming Sequence	Exit Programming Mode
* * * 0 0 0 0 0 0	2 Short Beeps Will be Heard	2 # Set Unit ID (1 to 7)	# 0 # 3 Short Beeps Will be Heard
		# Set Number of Units in Chain (1 to 7)	

For more information refer to the Keypad Programming Manual

Troubleshooting

Common Mistakes

- Check for correct length and AWG of wires. See page 3.
- Check that wires are correctly inserted into the terminal blocks (not loose, no two sharing the same position).
- Check board markings for correct terminal block placements.
- Make sure high voltage and data wires **do not share** the same conduit.
- Use metal conduit, **not PVC**.

No power to EL25

- Check power at source. Power **must** come from a **dedicated 110VAC** outlet.
- The transformer's outlet should be wired to its **own** circuit breaker.
- Check **"SYS PWR"** LED indicators. If **"LO"** or **"HI"** are lit, press **"PWR MON RST"** button. If either of those two LEDs are still lit, check transformer and outlet.

Door Strikes/Maglocks/Gate Operator not working

- Check power source. Strikes, Maglocks and Gate Operator **must** be powered **independent** from unit.
- Connect and test different Strike or Maglock. Make sure Strike or Maglock is **not defective**.
- **Door Strike:** Pin connections **"NO"** and **"COM"** at Relay terminal.
- **Mag Lock:** Pin connections **"NC"** and **"COM"** at Relay terminal.
- **Gate Operator:** Pin connections **"NO"** and **"COM"** at Relay terminal.

Postal Lock or AutoCall device not working

- Short **"IN"** and **"COM"** pin connections to verify functionality. If wiring is correct and device still does not work, contact technical support.

Card Reader not communicating with EL25

- Check Wiegand reader module connections.
- Connect and test a functioning reader. Make sure reader is not defective.
- Did you add the card(s) to the database while in programming mode?
- Check card format compatibility. The EL25 is only compatible with 26 and 30-bit cards.
- Review the transactions using Versa XS, if applicable, and check whether card failed.

Phone not functioning with the EL25

- Did you wire the Bypass Board correctly? See page 7.
- Is Bypass Board switch set to **"OPERATE"**?
- Did you wire the surge suppressor correctly? See page 7.
- Using an alarm system? If so, see page 8.
- Using an alarm system on multiple unit configuration? If so, see page 9.

Aux Open / Exit Request device not working

- Did you assign a relay to the REX? See the EL25 Programming Manuals.
- Check connections at Door # terminal(s). Wires to **"COM"** and **"EXT REQ #"** connection.

Transmitter not working

- Did you use the correct coaxial cable? See page 3.
- Is the remote antenna installed correctly? Is it **outside** of the EL25 enclosure?
- Did you add the transmitter(s) to the database as a transmitter or a access card while in programming mode?
- Only Passport transmitters can be used.

EL25 Repair Parts

Installation and Service Information are Available 6 Days a Week

Call our Toll Free Number **1-800-528-2806**

Monday through Friday 5:00 am to 6:00 pm (Mountain Std. Time)

Saturday 7:00 am to 3:30 pm (MST)

www.chamberlain.com

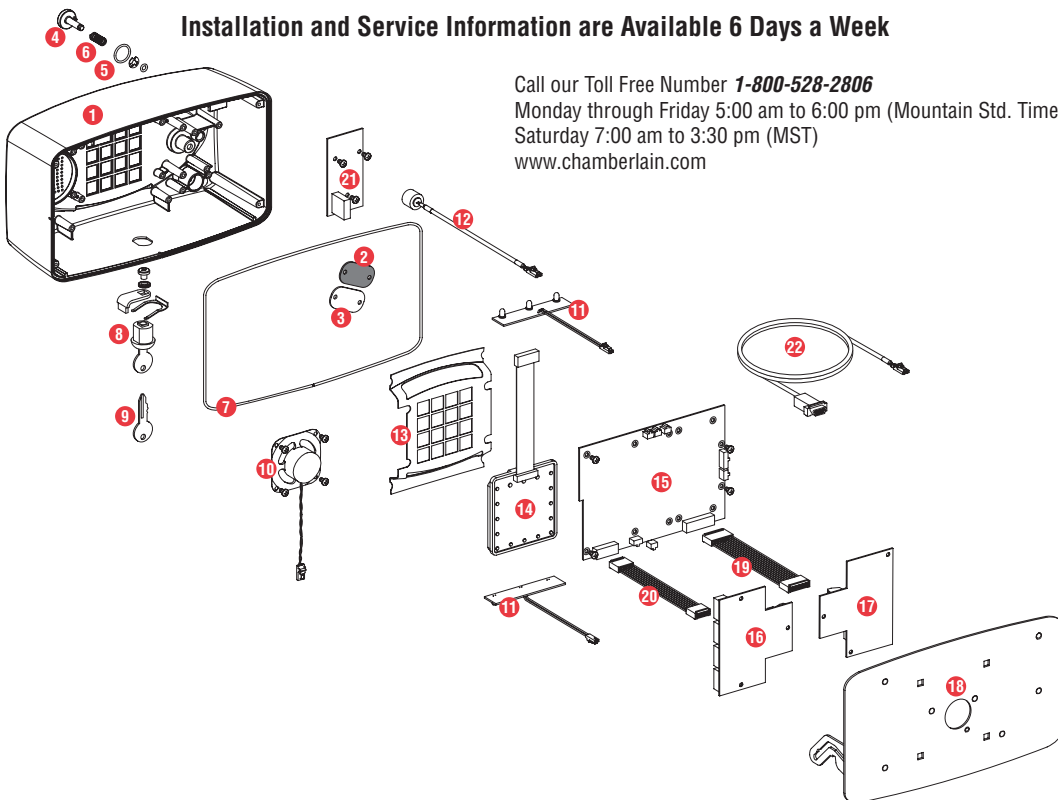

When ordering repair parts, Please supply the following information:

Part Number, Description and Model Number

Part Description	Part Number	Part Description	Part Number
1 Silver Cover	093D0341	12 Assembly, Mic Cable, EL25	002B0692
Nickel Cover	093D0341-1	13 Gasket, Key Pad	084C0087
Dark Gray Cover	093D0341-2	14 Assembly Keypad 16 Button	180D0236
2 Lens Black, Camera	108B0081	15 Assembly EL25 Main Board	002B0735
3 Lens Clear, Camera	108B0081-1	16 Assembly PCB Output Board	002B0737
4 Actuator, Call Button, Silver	101A0159	17 Assembly PCB Input Board	002B0736
5 E-Ring, Call Button	158A0094	18 Assembly, Mounting Back, Silver EL25	002C0607
6 Spring, Call Button	177A0166	Assembly, Mounting Back, Nickel EL25	002C0607-1
7 Gasket, Back	084B0081-1	Assembly, Mounting Back, Mist Gray EL25	002C0607-2
8 Assembly Lock EL25	002B0809	19 Assembly, 20-Pin Cable, EL25	002B0705
9 Key	TBD Call	20 Assembly, 14-Pin Cable, EL25	002B0704
10 Assembly, Speaker EL25	002B0639	21 Assembly, Call Button Board	002B0731
11 Assembly, LED	002B0721	22 Direct Connect Cable	002B0747

EL25 Repair Parts

Your System Diagram

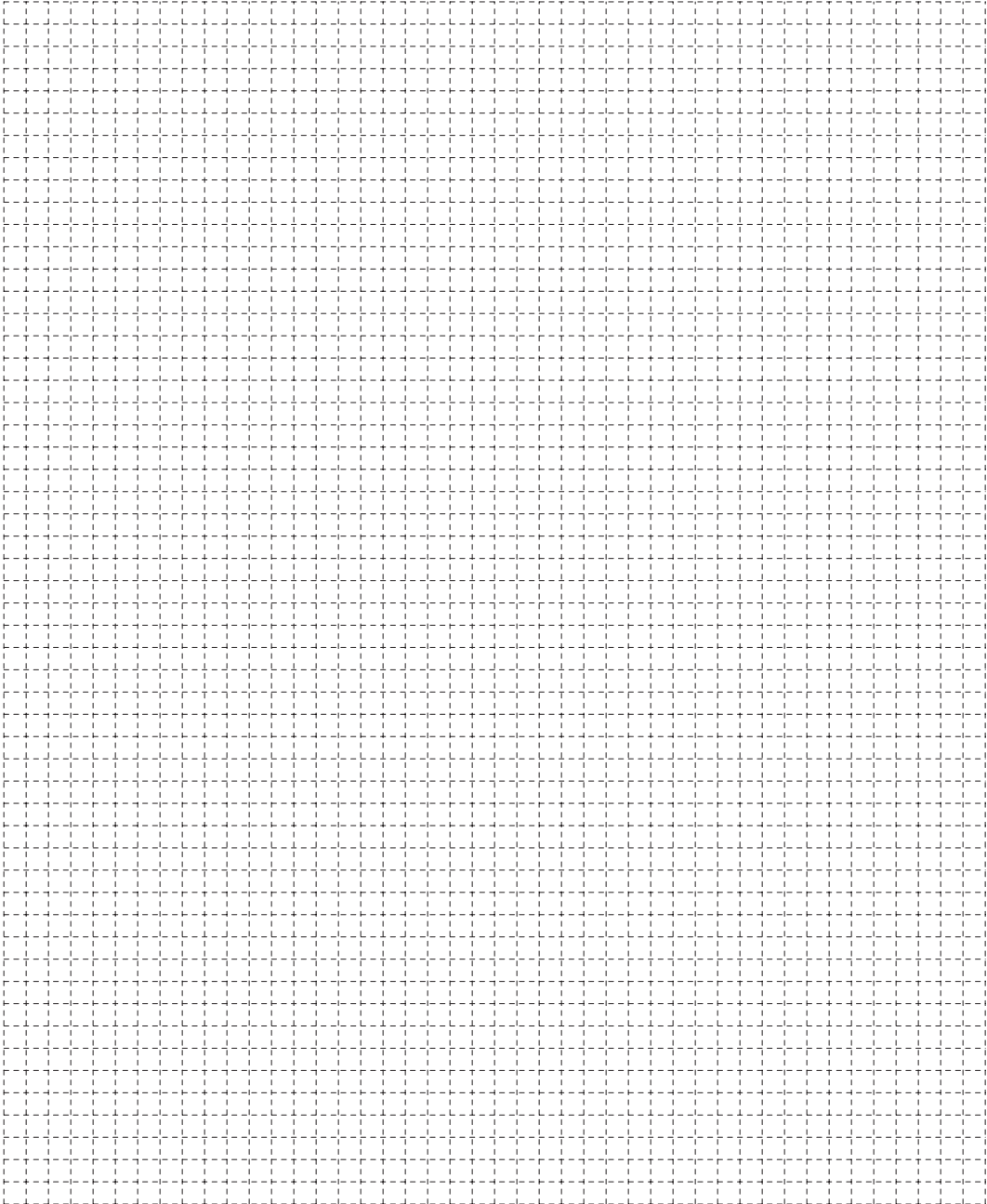

Your Wiring Configuration

External Access Control Device (s) connected to optional board(s)

Device 0 (Default Internal Keypad) _____

J400 Position

Device 1 _____

Device 2 (Wiegand Only) _____

J407 Position

Device 3 _____

Device 4 (Wiegand Only) _____

Relay Connections (Output Board)

Relay 1 _____

Relay 2 _____

Relay 3 _____

Relay 4 _____

Door Connections (Input Board)

Door 1 Connection Door Sensor *and/or* Exit Device

Door 2 Connection Door Sensor *and/or* Exit Device

Door 3 Connection Door Sensor *and/or* Exit Device

Door 4 Connection Door Sensor *and/or* Exit Device

Postal Lock Yes No

AutoCall Device Yes No

CCTV Camera Yes No

Dealer / Installer

EL25 Accessories

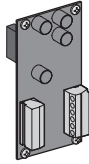

Wiegand Module Kit
WOMODKT

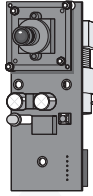

Black and White Camera Kit
EL25BWCAMKT

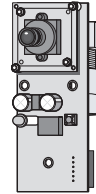

Low Lux DVR Color Camera Kit
EL25DVRCAMKT

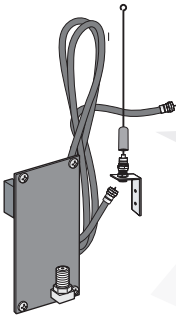

RF Module Kit
RFMODKT

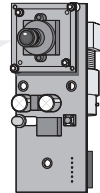

Color Camera Kit
EL25CCAMKT



Wiegand Remote Keypad
ESSWOKSG



Wiegand Remote Keypad/Prox Combo
HIDWOKPRO



Versa XS Software
VERSWR10

FCC and DOC Requirements

FCC Requirements

The EL25 system complies with Part 68 of the FCC Rules. The label affixed to this equipment contains, among other information, the FCC Registration Number and Ringer Equivalence Number (REN) for this equipment. You must, upon request, provide this information to your telephone company.

The REN is useful to determine the quantity of devices you may connect to your telephone line and still have all of those devices ring when your telephone number is called. In most, but not all areas, the sum of the RENs of all devices connected to one line should not exceed five (5.0). To be certain of the number of devices you may connect to your line, as determined by the REN, you should contact your local telephone company. They will tell you what the maximum REN is for your calling area.

The following jacks must be ordered from the telephone company in order to interconnect this equipment with the public communication network: None.

If your EL25 system causes harm to the telephone network, the Telephone Company may discontinue your service temporarily. If possible, they will notify you in advance. If advance notice is not practical, you will be notified as soon as possible. You will be informed of your right to file a complaint with the FCC.

Your Telephone Company may make changes in its facilities, equipment, operations or procedures that could affect the proper functioning of your equipment. If they do you will be notified, in advance, to give you an opportunity to maintain uninterrupted telephone service.

Connections to party lines are subject to state tariffs. Contact your local telephone company if you plan to use this equipment on party lines.

This equipment cannot be used on public coin service lines provided by the telephone company.

DOC Requirements

Notice: The Canadian Department of Communications label identifies certified equipment. This certification means that the equipment meets certain telecommunications network protective, operational, and safety requirements. The Department does not guarantee the equipment will operate to the user's satisfaction.

Before installing this equipment, users should ensure that it is permissible to be connected to the facilities of the local Telecommunications Company. The equipment must also be installed using an acceptable method of connection. In some cases, the company's inside wiring associated with single line individual service may be extended by means of a certified connector assemble (telephone extension cord). The customer should be aware that compliance with the above conditions may not prevent degradation of service in some situations. Repairs to certified equipment should be made by an authorized Canadian maintenance facility designated by the supplier. Any repairs or alterations made by the user to this equipment, or equipment malfunctions, may give the telecommunications company cause to request the user to disconnect the equipment.

Users should ensure for their own protection that the electrical ground connections of the power utility, telephone lines, and internal metallic water pipe unit, if present, are connected together. This precaution may be particularly important in rural areas.

Caution: Users should not attempt to make such connections themselves, but should contact the appropriate electric inspection authority, or electrician, as appropriate.

The **Load Number (LN)** assigned to each terminal device denotes the percentage of the total load to be connected to a telephone loop, which is used by the device, to prevent overloading. The termination on a loop may consist of any combination of devices subject only to the requirement that the total of the Load Numbers of all the devices does not exceed 100. The Load Number for the EL25 is 3.

Appendix

Accessories _____ **24**

Configuration

– **Multi-Unit** _____ **19**

Installation

– **Grounding** _____ **16**

– **Mounting** _____ **4-5**

– **Opening the Unit** _____ **4**

– **Power Up/LED Status** _____ **18**

Parts Replacement _____ **21**

Regulatory Information _____ **25**

Troubleshooting _____ **20**

Volume _____

– **Microphone/Speaker** _____ **19**

Appendix

Wiring

– AutoCall	13
– Camera	15
– Door Sensing Device	13
– Door Strike	11
– EL25 Connections	2
– Gate Operator	12
– Key Switch	12
– Maglock	11
– Module Connections	2
– PIR (Passive Infrared Device)	12
– Postal Lock	15
– Power	17-18
– Power Specifications/Wire Distances	3
– REX (Exit Request Button)	12
– RF Module	14

Telco Line Connections

– Dedicated Line	9
– 1 EL25 Unit	6
– Internal Phone System	10
– Multiple EL25 Units	7
– No Telco Line	8

Wiegand Module	14
----------------	----

CHAMBERLAIN®

ELITE™

845 Larch Avenue
Elmhurst, Illinois 60125-1196