

REVISIONS

ZONE	REV.	DESCRIPTION	DATE	APPROVED
	J	Replace 2600-126 Motor w/2600-129, 2600-234 Capacitor with 2600-102 and 2600-239 w/2600-875 Cap Clamp	5/2/2012	D.C.
	K	Remove 2600-440 Bearing and 2600-453 Holder, Replace with Bearing Assy Kit 2600-466	6/20/12	D.C.

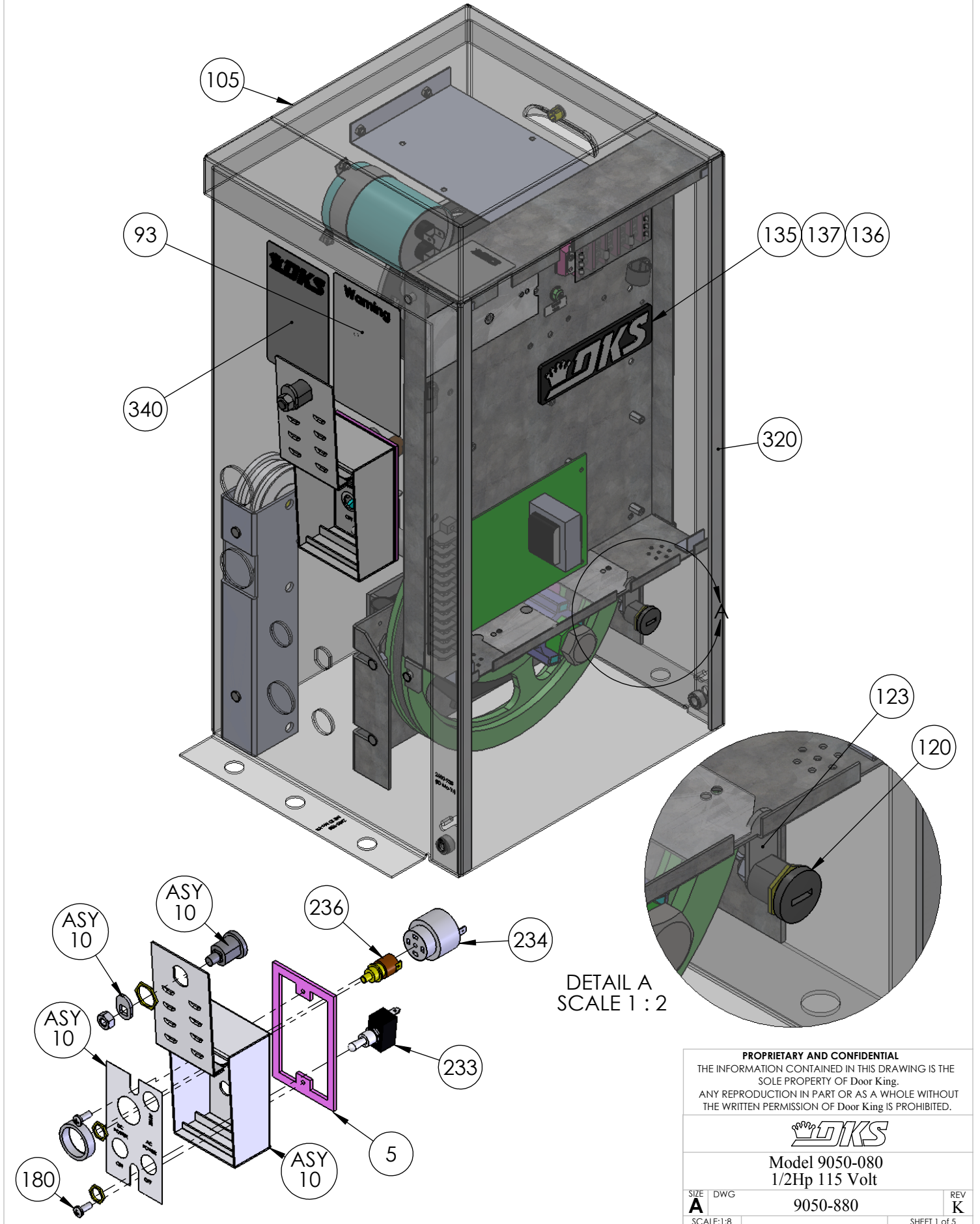

PROPRIETARY AND CONFIDENTIAL
 THE INFORMATION CONTAINED IN THIS DRAWING IS THE
 SOLE PROPERTY OF Door King.
 ANY REPRODUCTION IN PART OR AS A WHOLE WITHOUT
 THE WRITTEN PERMISSION OF Door King IS PROHIBITED.

DKS

Model 9050-080
 1/2Hp 115 Volt

SIZE A	DWG 9050-880	REV K
SCALE:1:8		SHEET 1 of 5

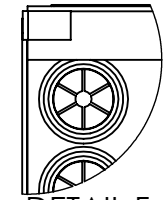

DETAIL F
SCALE 1 : 2

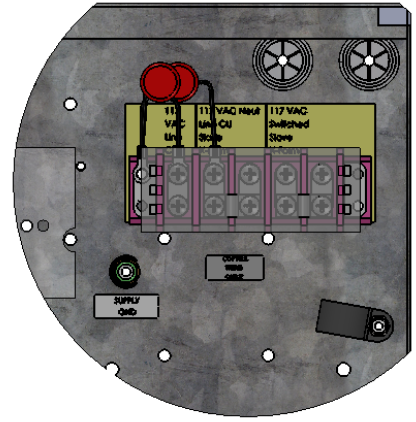
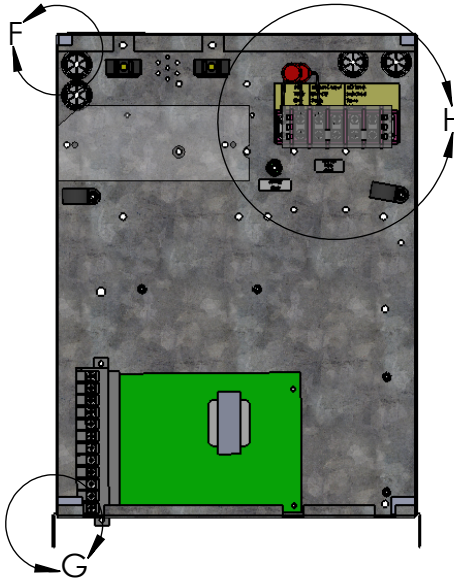

DETAIL H
SCALE 1 : 3

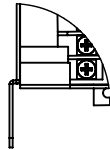
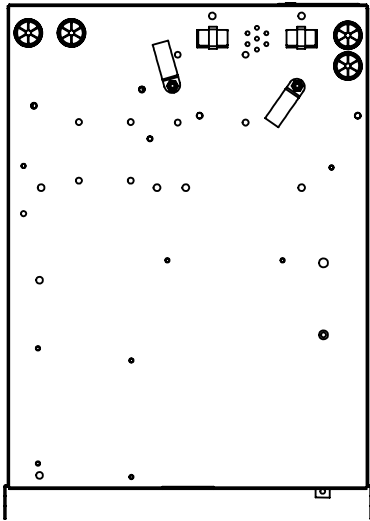

DETAIL G
SCALE 1 : 3

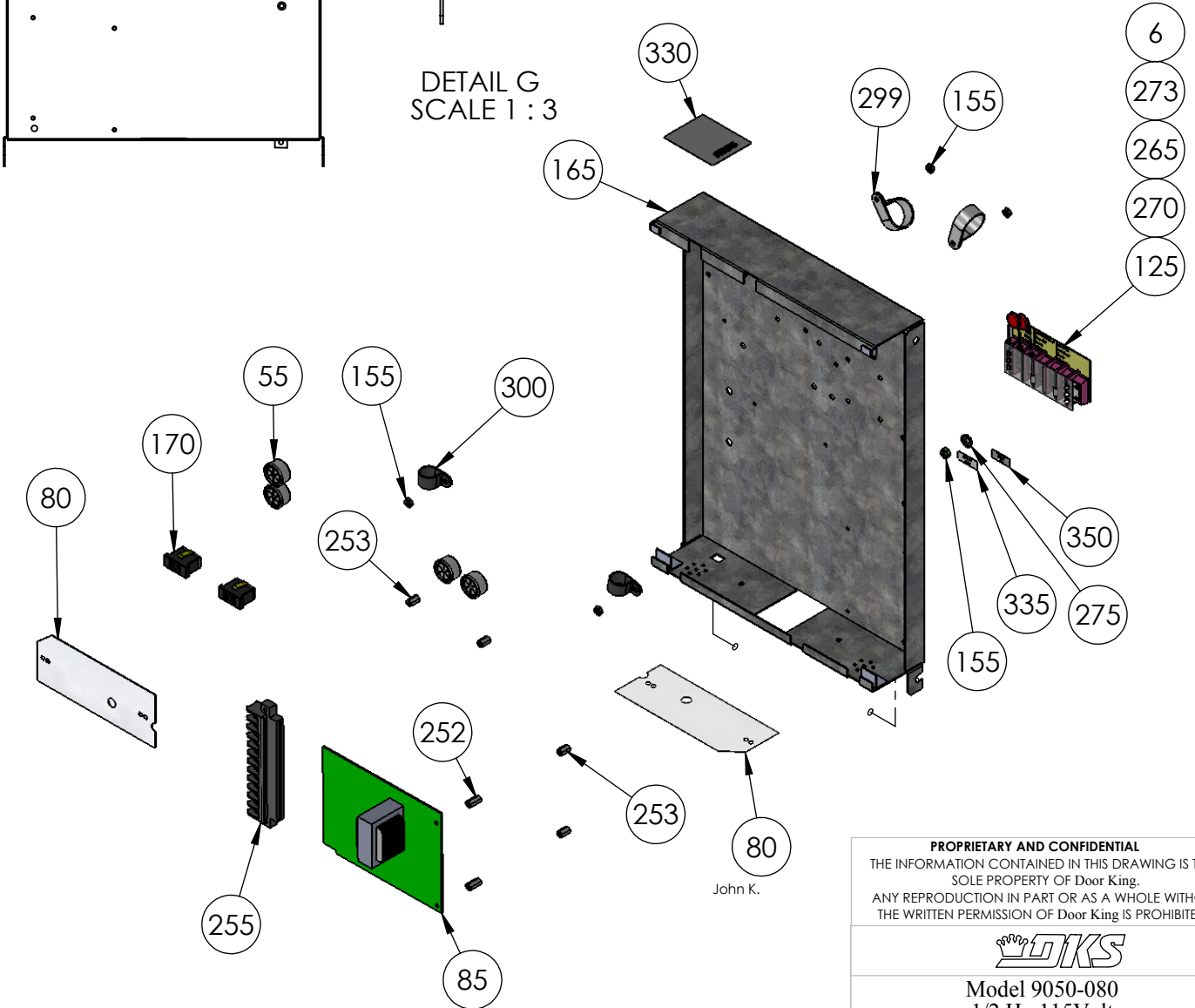

John K.

PROPRIETARY AND CONFIDENTIAL
THE INFORMATION CONTAINED IN THIS DRAWING IS THE
SOLE PROPERTY OF Door King.
ANY REPRODUCTION IN PART OR AS A WHOLE WITHOUT
THE WRITTEN PERMISSION OF Door King IS PROHIBITED.



Model 9050-080
1/2 Hp 115Volt

SIZE A	DWG 9050-880	REV K
SCALE: 1:4	SHEET 3 of 5	

ITEM	PART #	QTY	DESCRIPTION
1	9050-066	1 EA	Manual Installation
5	2600-731	1 EA	Gasket Switch Cover
6	4001-093	1 EA	MOV Assembly 130VAC
10	2600-533	1 EA	Switch Cover Dooring Lockable
15	2600-852	1 EA	Accessory Box 9150 Operator
19	2600-466	1 EA	Bearing Assembly Rear 910/915
35	2600-429	1 EA	Belt-Cogged, AX-35
40	2600-921	1 EA	Idler Bracket Left
45	2600-922	1 EA	Idler Bracket Right
50	2600-938	1 EA	Radio Tray 9100
55	2600-810	4 EA	Bushing 7/8 Poke Thru Flaps
60	2600-871	2 EA	Bushing 1/2"ODx5/16"IDx1 5/16L
65	2600-875	1 EA	Capacitor Mounting Clamp
70	2600-102	1 EA	Capacitor 50uf 370VAC
75	2600-342	1 EA	Clutch Pad 4" OD
80	2600-945	2 EA	Cover Plastic Insulator
85	4702-010	1 EA	PCB Slide Gate Operator
93	2599-034	1 EA	Label Gate Operator
99	2615-155	2 EA	Bolt Hex Head 5/16-18 x 1 3/4
100	2615-153	4 EA	Bolt Hex Head 5/16-18 x 3/4
105	2600-933	1 EA	Door Model 9050 9070 9100
110	2600-880	1 EA	Hole Plug Plastic for 3/8 Hole
115	2600-985	1 EA	Housing-Model 9050 9070 9100
120	4001-035	1 EA	Lock N16058BDxSfx2K Key 16120
123	1702-503	1 EA	Cam 1.1/4
125	2600-431	1 EA	Marker Strip Silkscreened
130	2600-129	1 EA	Motor Assy 1/2 HP 6100-9100
134	7082-137	1 EA	Wire 5" Green Stranded 14AWG
135	2600-732	1 EA	Nameplate Plastic DKS Big
136	2802-040	2 EA	Washer Push on Clamp
137	1897-050	2 EA	Gasket Support Thick 1/16"
140	2600-917	1 EA	Jam Nut Magnet Subassy 910/915
143	2620-409	4 EA	Nut Hex Flange Lock 1/4-20
145	2902-006	2 EA	Nut Nylon Lock 10-32
147	2902-004	1 EA	Nut Nylon Lock 8-32
150	2620-411	16 EA	Nut Hex Flange Lock 5/16-18
155	2902-003	12 EA	Nut Nylon Lock 6-32
165	2600-911	1 EA	Mount Plate-PC Board 910
170	1200-028	2 EA	Outlet Snap-In Leviton 1306
171	2600-957	1 EA	Pulley 10 inch Aluminum Assy
173	2616-051	2 EA	Screw Phillips 10-32x3/8
180	2616-052	1 EA	Screw Phillips Head 10-32 x1/2
185	2616-019	1 EA	Screw Phillips Head 8-32 x 3/4
190	2616-002	2 EA	Screw Phillips Head 6-32 x 1/2
195	2616-003	1 EA	Screw Phillips Head 6-32x3/4SS
200	2616-000	10 EA	Screw Phillips Head 6-32 x 1/4
205	2616-007	2 EA	Screw Phillips Head 6-32x5/8"
210	2600-887	4 EA	Screw Nylon Phillips 6-32x1/4"
215	2616-001	4 EA	Screw Phillips Head 6-32 x 3/8
220	2600-903	1 EA	Main Shaft Assembly
225	2600-930	1 EA	Bracket Shaft Support 9100
230	2600-860	1 EA	Solenoid Lock Assy 91XX
233	1601-041	1 EA	Switch Toggle SPST 2POS
234	1506-071	1 EA	Tone Generator Loud
235	2600-446	1 EA	Spring-Compression

IPB 9050-880 Rev K
 (Model and Movex No. 9050-080 Rev K)

ITEM	PART #	QTY	DESCRIPTION
236	1812-005	1 EA	Switch Push Button N.O.
248	2600-487	1 EA	Bracket Solenoid Support
252	1894-110	2 EA	Standoff Nylon 1/2"Ht 6-32 Thd
253	2900-905	4 EA	Standoff Aluminum 7/16" 6-32
255	2600-826	1 EA	Terminal 12 Pin
260	2600-886	2 EA	Idler Wheel UHMW
265	2600-840	2 EA	Jumper- Ring Tongue #8 Screw
270	3130-008	1 EA	Terminal Block 5 pin
273	3129-005	1 EA	Terminal Block Cover 5 Positio
275	2600-439	1 EA	Washer Cup - Brass
280	2620-053	2 EA	Lockwasher 5/16"
285	2600-053	1 EA	Bearing - Thrust 3/4 ID
286	2600-345	1 EA	Washer Hardened 1 1/4 x 3/4 ID
287	2600-344	1 EA	Washer 1 1/8"OD x 3/4"ID
288	2600-990	1 EA	Washer Neoprene 1.5"x.725"x125
289	2620-035	1 EA	Washer 4"ODx3/4"ID
298	2600-989	1 EA	Wire Set 9050 9070 Operator
299	2600-639	4 EA	Wire Clamp-1"
300	2600-619	4 EA	Wire Clp-5/8" Concord 770-1209
315	1804-031	10 EA	Tie Wrap 4"
317	2600-749	2 EA	Wire Connector STA-KON RC6
320	4001-018	7 FT	Weather Stripping 50' rolls
330	2599-008	1 EA	Label Patent
335	2599-006	1 EA	Decal SUPPLY GND
340	2599-199	1 EA	Label Universal
350	2599-014	1 EA	Decal Copper Wire Only
355	2560-047	1 EA	Information Packet 9050/9070
360	2599-100	2 EA	Sign Warning