

Installation/Owner's Manual

Model 1812 Plus

Residential Telephone Intercom/Access Control System

Use this manual for circuit board 1971-010 Revision M or higher.

1812-161-P-10-12

Control a main door and gate.

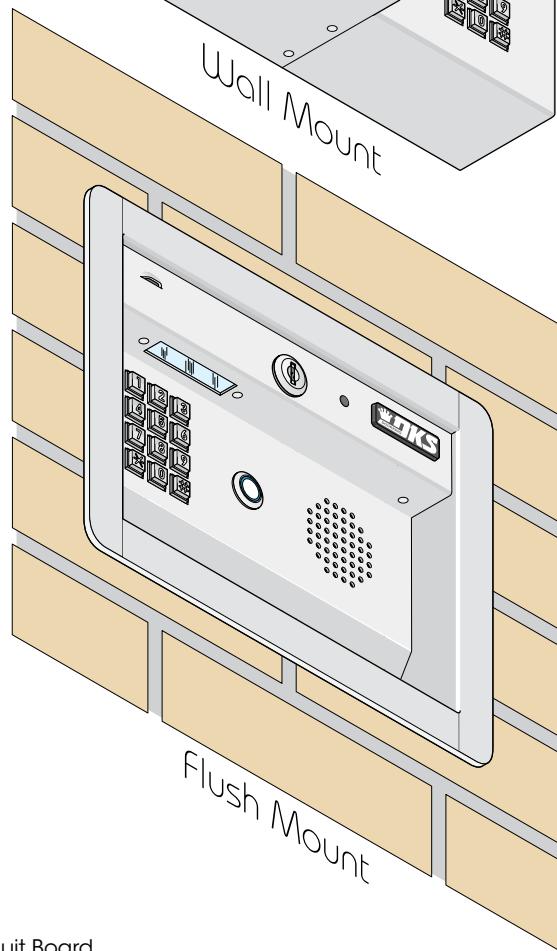
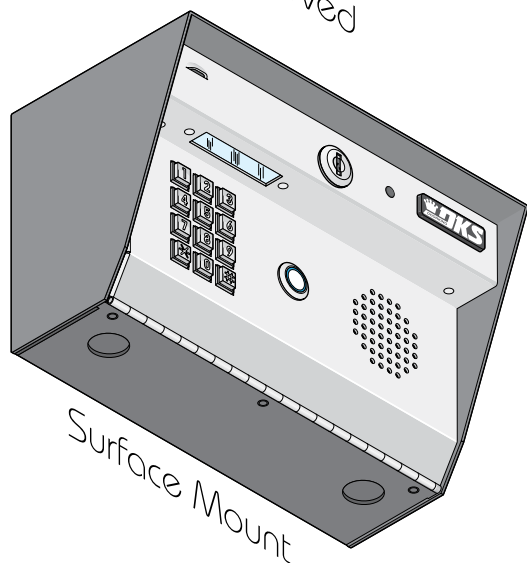
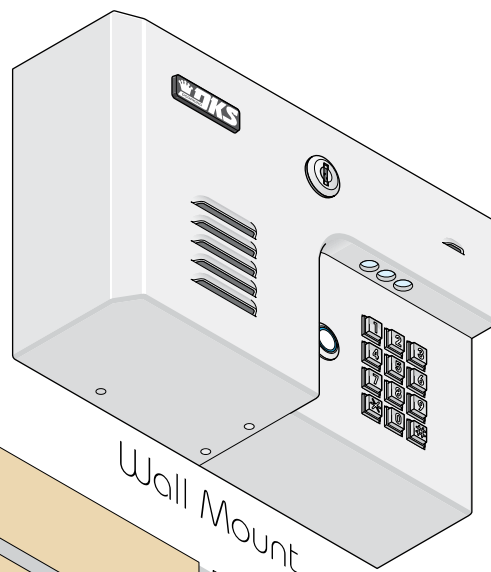
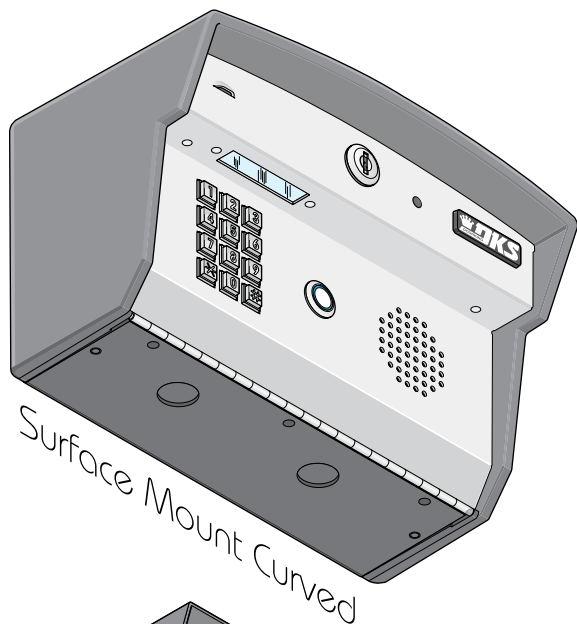

Date Installed: _____

Installer/Company Name: _____

Phone Number: _____

Circuit Board
Serial Number
and Revision Letter: _____

Leave Manual with Owner

Copyright 2012 DoorKing, Inc. All rights reserved.



SPECIFICATIONS

For Model 1812 Plus with circuit board 1971-010 Rev M or higher ONLY.

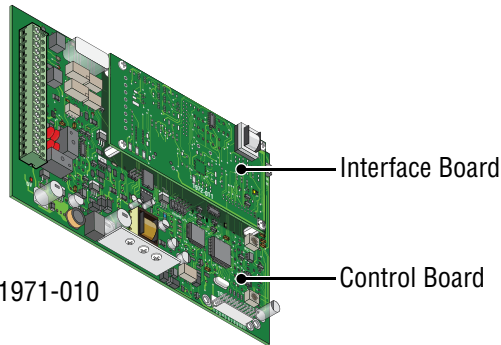

Both Boards Together - 1971-010

Features

- Unique telephone communication system allows homeowners to use their telephone as an intercom to speak to a guest at a front door or gate, and to control access to their property.
- Unique distinctive ring.
- Unit connects directly to the homeowners existing telephone line. No additional monthly expense for a second telephone line.
- Built in call waiting assures that incoming calls or guest calls are not missed.
- Call Forward.
- Up to 27 preprogrammed dial-out telephone numbers.
- Answer machine bypass feature. Allows the homeowner to log into the 1812 even after an answering machine has already picked up the call.
- Two internal relays allow the system to control a main entry gate plus a pedestrian access gate.
- Built-in clock / calendar provides the following time related functions:
 1. Do-not-disturb time zone.
 2. Four hold-open time zones.
 3. Access code time zones.
 4. Call forward time zone.
 5. 10 temporary access codes.
- Unit can be programmed to work with PBX and KSU phone systems.
- Optional secondary keypad can be added for remote access code activation of door or gate.

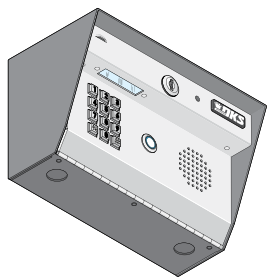

Surface Mount

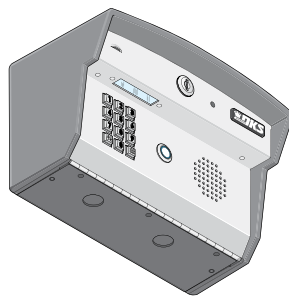

Surface Mount Curved

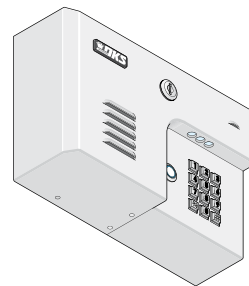

Wall Mount

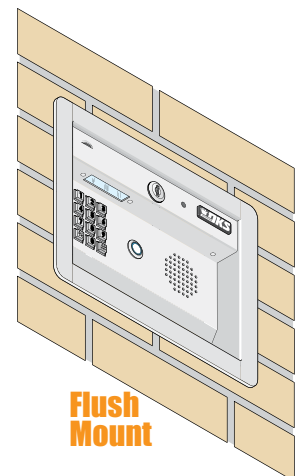

Flush Mount

DoorKing, Inc. reserves the right to make changes in the products described in this manual without notice and without obligation of DoorKing, Inc. to notify any persons of any such revisions or changes. Additionally, DoorKing, Inc. makes no representations or warranties with respect to this manual. This manual is copyrighted, all rights reserved. No portion of this manual may be copied, reproduced, translated, or reduced to any electronic medium without prior written consent from DoorKing, Inc.

SPECIFICATIONS

Surface Mount Dimensions

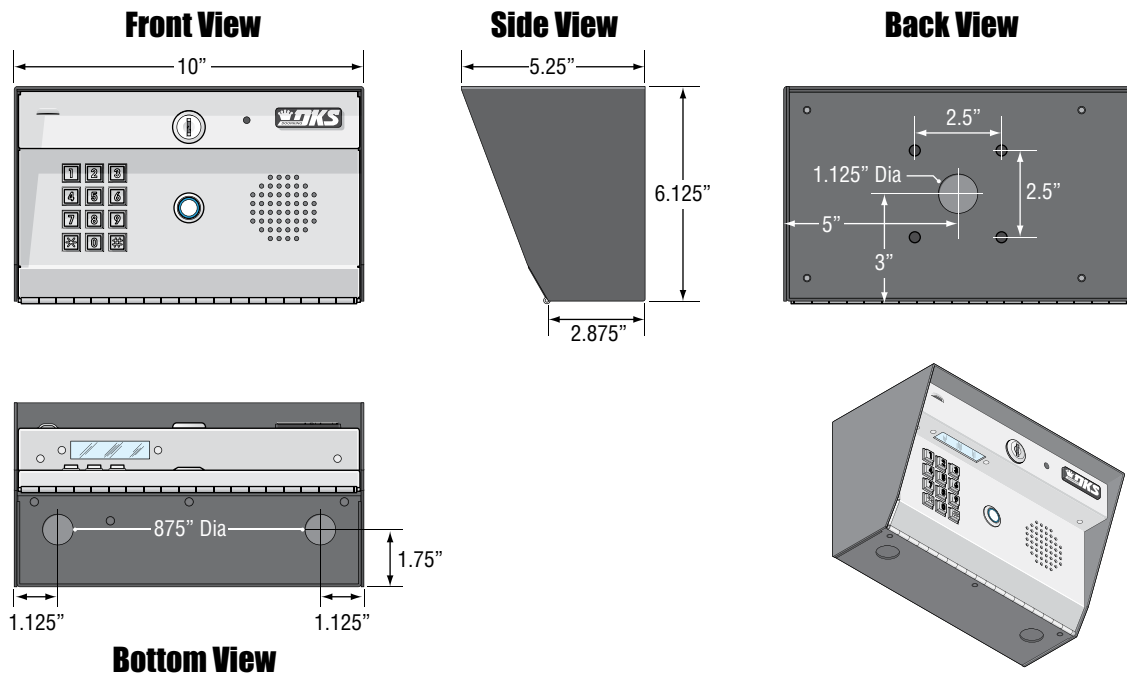

Surface Mount Curved Dimensions

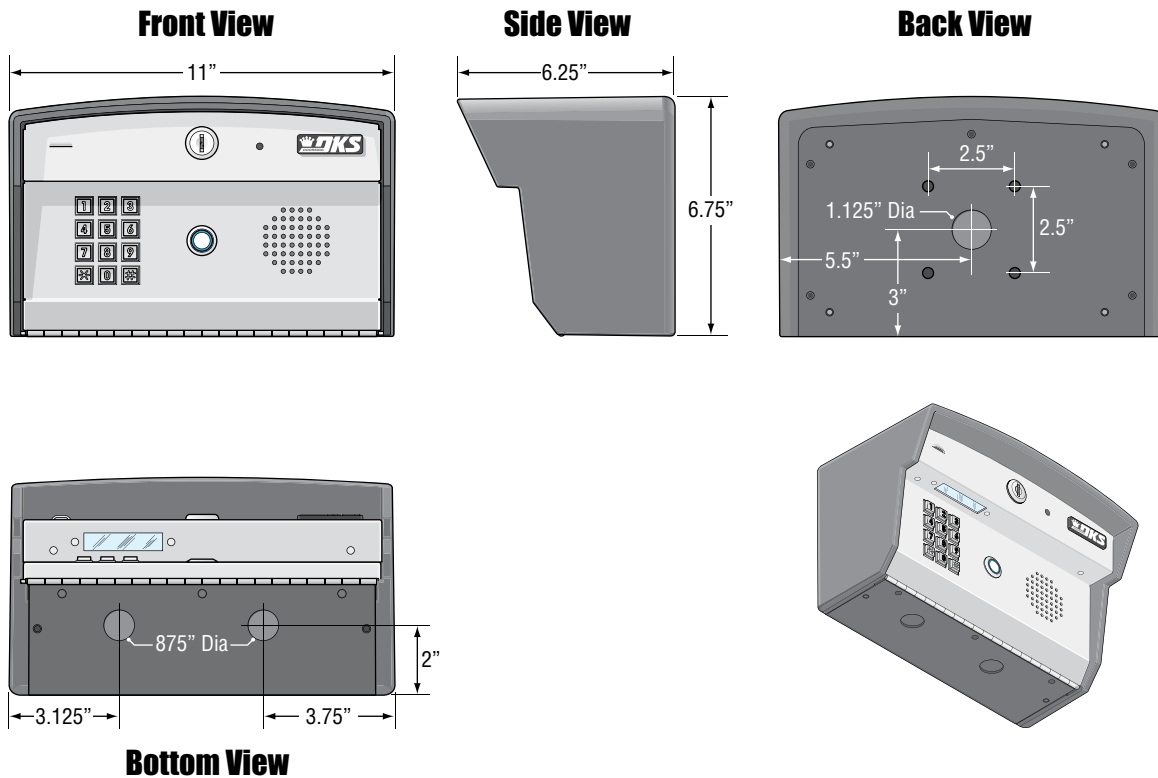

SPECIFICATIONS

Wall Mount Dimensions

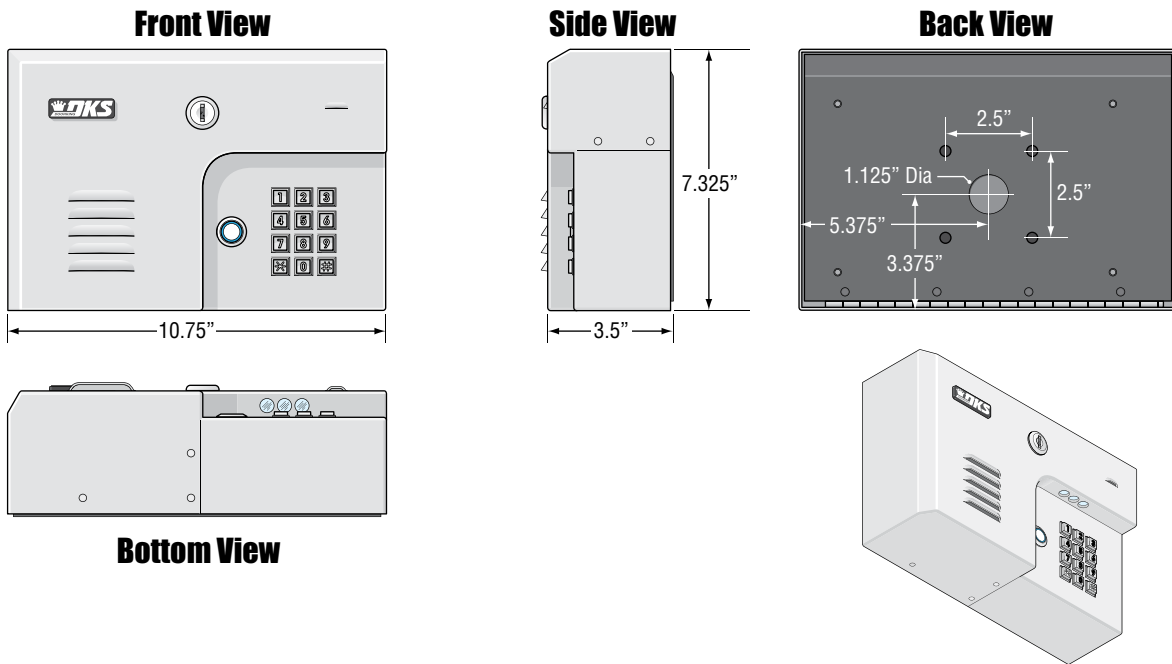

Flush Mount Dimensions

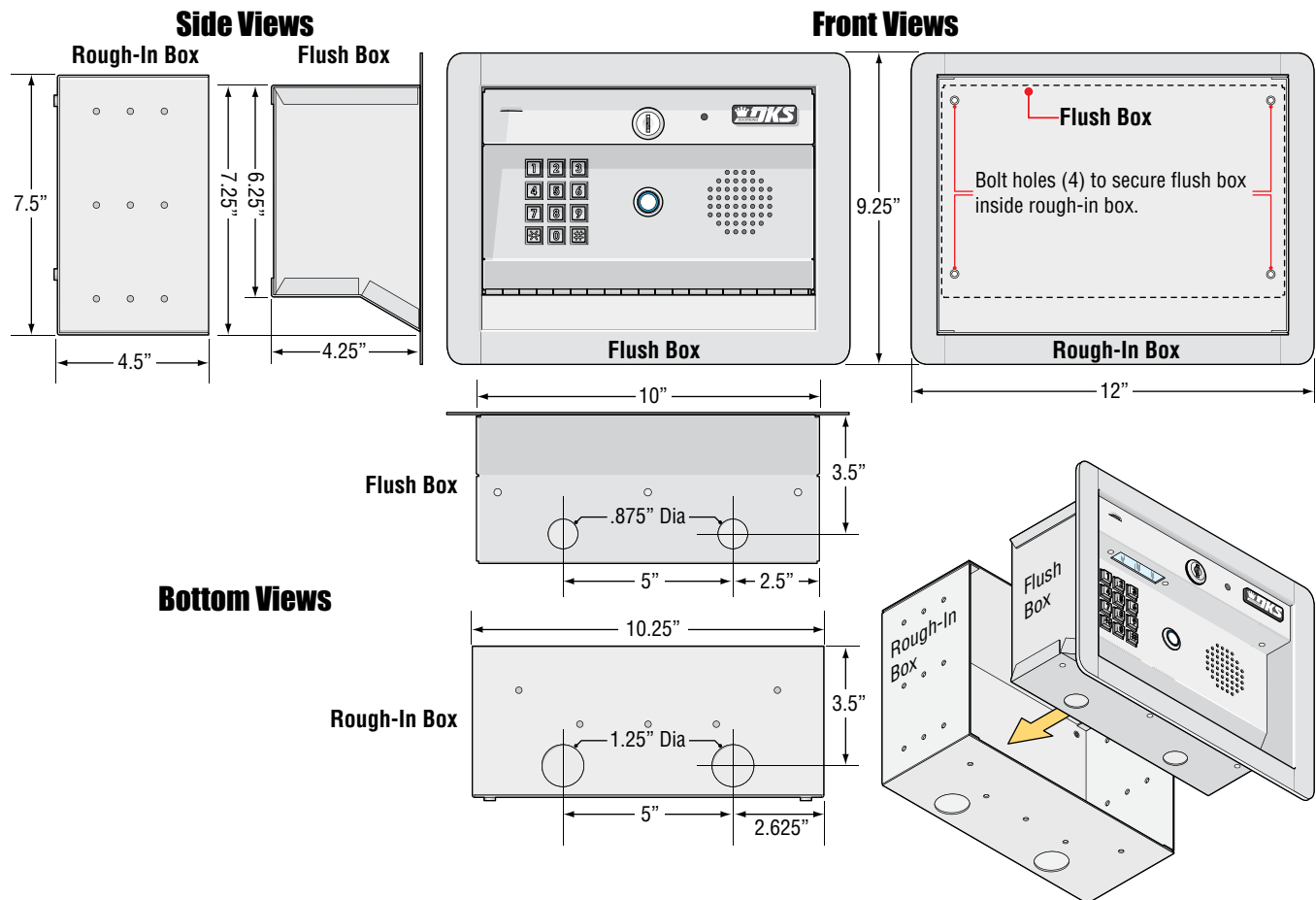

TABLE OF CONTENTS

SPECIFICATIONS	1
Features	1
Surface Mount Dimensions	2
Surface Mount Curved Dimensions	2
Wall Mount Dimensions	3
Flush Mount Dimensions	3
Important Notices FCC - United States, DOC - Canada	4
General Information Installation Guidelines and Safety Information	5
SECTION 1 - INSTALLATION	8
1.1 Mount the 1812 Plus	8
Different Mounting Configurations of the 1812 Plus Models	9
1.2 Install By-Pass Board for “Telephone Mode” Configurations	11
1.3 Telephone Line Wire	12
1.4 16.5 VAC Power Wiring ONLY!	13
1.5 Grounding and Surge Suppression	13
1.6 Wiring One 1812 to a Telco Line - Telephone Mode	14
1.7 Wiring One 1812 to the Internet - Telephone Mode	15
1.8 Wiring Multiple 1812s: Telco/Internet - Telephone Mode	16
1.9 Wiring a Single 1812 - Intercom Mode	17
1.10 Wiring Multiple 1812s - Intercom Mode	18
1.11 Main Terminal Description	19
SECTION 2 - PROGRAMMING	19
2.1 Programming Methods	19
2.2 Programming the Master Code	20
2.3 System Parameters Programming	21
Programming from the System Keypad	21
Programming from a Touch-Tone Telephone	21
Quick Reference Table	22
2.3.1 Phone Mode or Intercom Mode	23
2.3.2 Single or Multiple Systems	23
2.3.3 System Attention Number	23
2.3.4 Single or Double Ring	23
2.3.5 Number of Home Phone Rings Before 1812 Hangs Up	23
2.3.6 Talk Time	24
2.3.7 Relay Strike Time	24
2.3.8 Tone Open Numbers	24
2.3.9 Answer Incoming Call on X Rings	25
2.3.10 Hang Up Tone Number	25
2.3.11 Call Waiting	25
2.3.12 Turn Speaker On / Control Relay from Off-Site Call	25
2.3.13 Set Call Forward Microphone Gain and Speaker Volume	26
2.4 Directory Codes	26
2.4.1 Directory Codes 24 – 50 Programming “Dial Phone Number”	26
2.4.2 Delete a Phone Number from Directory Codes 24 – 50	26
2.4.3 Delete ALL Phone Numbers from Directory Codes 24 – 50	26

TABLE OF CONTENTS

2.5 Access Codes to Operate Access Control Devices	27
2.5.1 “Simple” Access Code Programming (24/7 Operation)	27
2.5.2 “Time Zone Restricted” Access Code Programming	27
2.5.3 Delete an Access Code (Simple and Time Zone Restricted)	27
2.5.4 Delete All Access Codes (Simple and Time Zone Restricted)	28
2.5.5 “Temporary” Access Code Programming	28
2.5.6 Delete a “Temporary” Access Code	28
2.5.7 Delete All “Temporary” Access Codes	28
2.6 Time Functions	29
2.6.1 Time and Date Calendar Chip Programming	29
2.6.2 Call Forward Phone Number Programming	29
2.6.3 Call Forward ON/OFF or Time Zone Activation	30
2.6.4 Do Not Disturb Time Zone Programming	30
2.6.5 Automatic Relay Activation Time Zone Programming (Up to 4)	31
2.6.6 Access Code Time Zone Programming (Up to 4)	31
2.7 Miscellaneous	32
2.7.1 Restore Factory Settings	32
SECTION 3 - ADJUSTMENTS	33
Speaker Volume	33
Microphone Gain	33
Interface Board LED Status	33
System Keypad and Push To Call Button	33
SECTION 4 - USER INSTRUCTIONS	34
4.1 Resident Operating Instructions	34
4.1.1 Granting or Denying a Guest Access	34
4.1.2 Call Waiting	34
4.1.3 Dial-Out Phone Numbers	34
4.1.4 Access Codes	34
4.2 Remote Operation	35
4.2.1 Remote Programming (Homeowner’s Phone or Off-Site Phone)	35
4.2.2 Remote Relay Activation (Off-Site Phone)	35
4.2.3 Relay Activation from Homeowner’s Phone	35
4.2.4 Relay Activation Check from Homeowner’s Phone	35
4.2.5 Initiate Talk and Listen to 1812 when it has not been activated	36
SECTION 5 - MAINTENANCE	36
5.1 Troubleshooting	36
5.2 Phone Line Polarity	37
5.3 Isolating Noise Problems	38
5.4 Troubleshooting Table	38-39
5.5 Wiring Schematic	40
5.6 Accessories	40
5.7 Programmed Information Log Sheets	41-47
Master Code, Relays, Access Codes and Time Zone Log Sheet; Directory Code / Dial-Out Phone Numbers Log Sheet; Access Code Log Sheets (50 with phone numbers, 50 as access only), 1-10 Temporary Access Codes Log Sheet and extra log sheet.	

Important Notices

FCC – United States

This equipment has been tested and found to comply with the limits for a class A digital device, pursuant to Part 15 of the FCC Rules and Regulations. These limits are designed to provide reasonable protection against harmful interference when the equipment is operated in a commercial environment. This equipment generates, uses, and can radiate radio frequency energy and, if not installed and used in accordance with the instruction manual, may cause harmful interference to radio communications. Operation of this equipment in a residential area is likely to cause harmful interference in which case the user will be required to correct the interference at his own expense.

FCC Registration Number: **DUF6VT-12874-0T-T**

DOC - Canada

The Canadian Department of Communications label identifies certified equipment. This certification means that the equipment meets certain telecommunications network protective, operational, and safety requirements. The Department does not guarantee the equipment will operate to the users satisfaction.

Before installing this equipment, users should ensure that it is permissible to be connected to the facilities of the local telecommunications company. The equipment must also be installed using an acceptable means of connection. The customer should be aware that compliance with the above conditions may not prevent degradation of service in some situations.

Repairs to certified equipment should be made by an authorized Canadian maintenance facility designated by the supplier. Any repairs or alterations made by the user to this equipment, or equipment malfunctions, may give the telecommunications company cause to request the user to disconnect the equipment.

Users should ensure, for their own protection, that the electrical ground connections of the power utility, telephone lines, and internal metallic water pipe system, if present, are connected together. This precaution may be particularly important in rural areas.

CAUTION: Users should not attempt to make such connections themselves, but should contact the appropriate electric inspection authority, or electrician, as appropriate.

DOC Registration Number: **1736 4507 A**

Notice:

The Load Number (LN) assigned to each terminal device denotes the percentage of the total load to be connected to a telephone loop which is used by the device, to prevent overloading. The termination on a loop may consist of any combination of devices subject only to the requirement that the sum of the load numbers of all the devices does not exceed 100.

Notice:

DoorKing does not provide a power transformer on units sold into Canada. Use only transformers that are CSA listed to power the telephone entry system. The model 1812 Plus requires a 16.5-volt, 20 VA transformer.

General Information

- Prior to beginning the installation of the telephone entry system, we suggest that you become familiar with the instructions, illustrations, and wiring guidelines in this manual. This will help insure that you installation is performed in an efficient and professional manner.
- The proper installation of the telephone entry panel is an extremely important and integral part of the overall access control system. Check all local building ordinances and building codes prior to installing this system. Be sure your installation is in compliance with local codes.
- When used to control a door or pedestrian gate, try to locate the telephone entry system as near as possible to the entry point. The unit should be mounted on a rigid wall to prevent excessive shock and vibration from closing doors or gates. Continuous vibration and shock from slamming doors or spring-loaded pedestrian gates will damage the circuit board.
Under no circumstances should the unit be mounted directly to a moving door or gate.
- **ADA mounting requirements for door control.** The requirements below apply only when the telephone entry system is being used to control entry through a public door only. If this system is used to control entry through a vehicular gate or private entrance, the dimensions noted below do not apply.
 1. If the clear floor space allows only forward approach to the system, the maximum high forward reach allowed is 48 inches above grade to the top of the keypad.
 2. If the high forward reach to the system is over an obstruction of greater than 20 inches but less than 25 inches, the maximum high forward reach allowed is 44 inches above grade to the top of the keypad.
 3. If the clear floor space allows parallel approach by a person in a wheelchair, the maximum high side reach shall be 54 inches above grade to the top of the keypad.
 4. If the high side reach is over an obstruction of 24 inches or less, the maximum high side reach allowed is 46 inches above grade to the top of the keypad.
- **When used to control a vehicular gate with an automatic gate operator, the telephone entry system must be mounted a minimum of ten (10) feet away from the gate and gate operator, or in such a way that a person cannot operate the entry system and/or touch the gate or gate operator at the same time.**
- Be sure that the system is installed so that it is not directly in the traffic lane. Goose neck mounting post and kiosks work well for these type systems. When planning where to locate the system, take into consideration traffic lane layouts, turn around lanes for rejected access, conduit runs, power availability, etc.
- Environmental factors must also be taken into account. Surface mount units are designed for direct outdoor installations, however it is preferable to protect them from direct exposure to driven rain or snow whenever possible. Flush mount units must be protected from direct exposure to the elements.
- This telephone entry system contains a number of static sensitive components that can be damaged or destroyed by static discharges during installation or use. Discharge any static prior to removing the circuit board from the lobby panel by touching a proper ground device.
- **Instruct the end user to read and follow these instructions. Instruct the end user to never let children play with or operate any access control device. This Owner's Manual is the property of the end user and must be left with them when installation is complete.**

SECTION 1 - INSTALLATION

Installation of the 1812 Plus Telephone Entry System involves the installation of the hardware, by-pass board, and the wiring of these components. Be sure that all dirt, metal or wood debris is removed from inside after mounting it. Any debris inside could damage the control board and cause the 1812 Plus system to malfunction during operation.



When the 1812 Plus is used to control a vehicular gate with an automatic gate operator, it must be mounted a minimum of ten (10) feet away from the gate and gate operator, or in such a way that a person cannot operate the 1812 Plus system and/or touch the gate or gate operator at the same time.

1.1 Mount the 1812 Plus

Use the specification dimensions on pages 2 and 3 to help with the installation of your chosen 1812 Plus model.

Remove the Control Board

The control board removal is the same for all models.

CAUTION The control board contains static sensitive components. Discharge any static electricity from your hands by touching a proper ground device **before** removing the control board.

1. Unlock and open the 1812 door.
2. Disconnect the keypad plug and door accessories plug from the control board.
3. Remove the 4 screws.
Carefully remove control board.

Keep the control board in a protected area during the mounting installation.

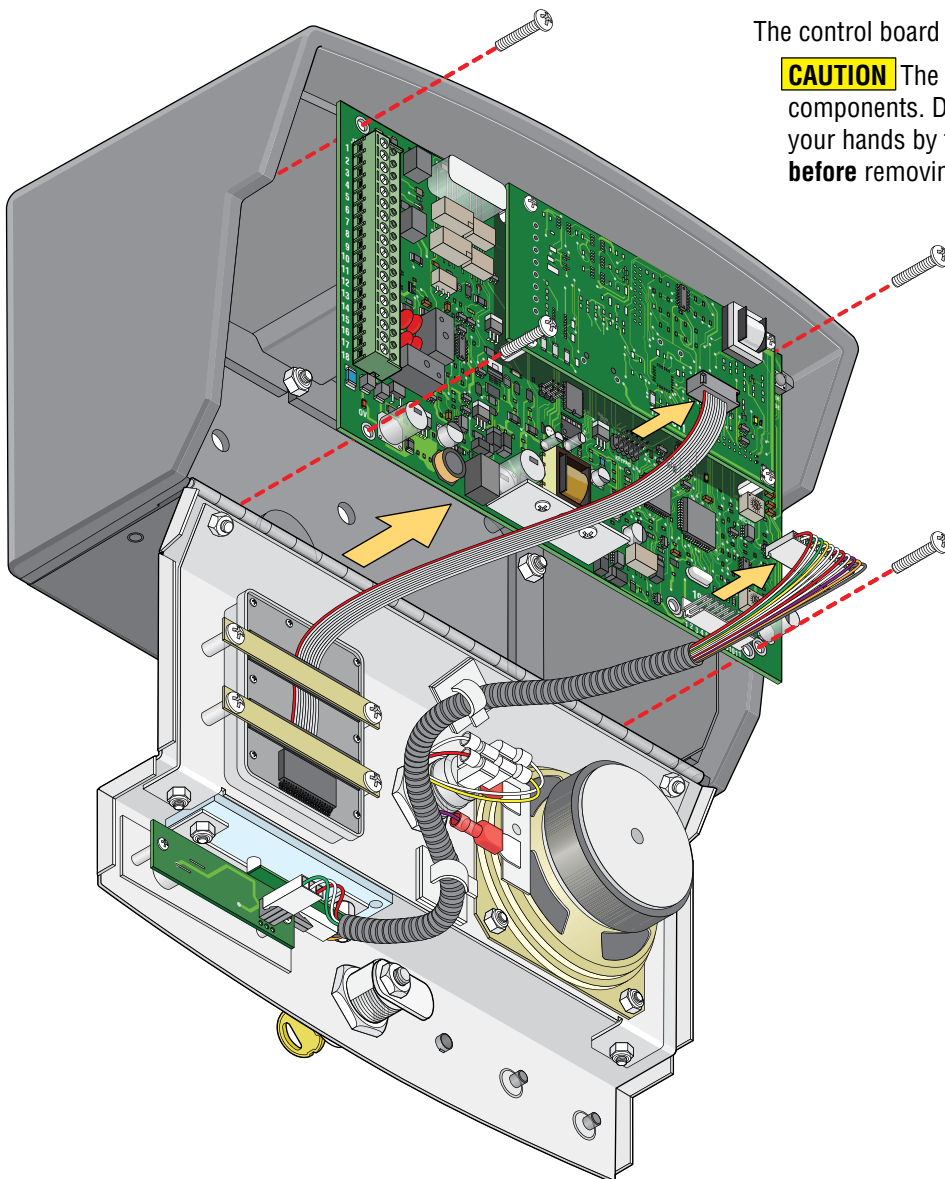

Different Mounting Configurations of the 1812 Plus Models

Surface and Wall mount models can be mounted directly to a wall, pilaster or post mounted using a DoorKing mounting post (there are several different styles available). The flush mount model is designed to be mounted into a pilaster, wall or kiosk. In any case, be sure it is securely mounted and is not subject to continuous vibration from closing doors or gates.

Mount on a Mounting Post

Use existing 4 holes in cabinet box to bolt the surface or wall mount models on a DoorKing mounting post. Use the hardware that is supplied with the mounting post.

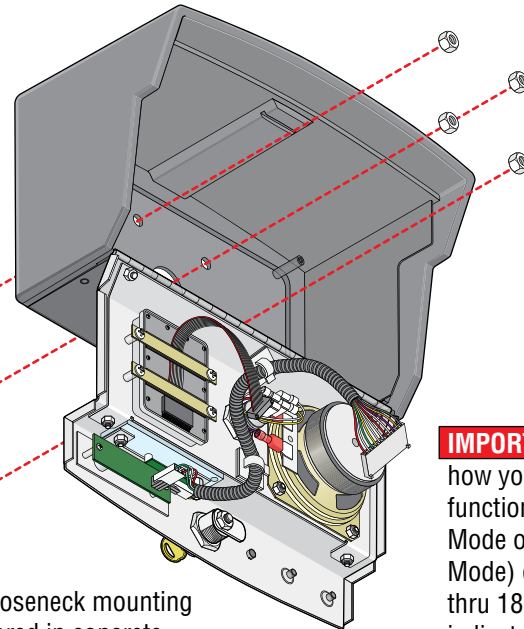

Note: A gooseneck mounting post anchored in concrete does not make a good ground.

IMPORTANT Choose how your 1812 will function (Telephone Mode or Intercom Mode) on pages 14 thru 18 and run the indicated wires to the cabinet. Run ALL wires that will be needed during the cabinet installation.

Mount Directly to a Wall or Pilaster

Use the 4 existing holes in the cabinet box. Run conduit inside or outside of wall or pilaster if desired. Use appropriate hardware to mount the cabinet (Not supplied). Be sure that the mounting hardware does not protrude into the cabinet where it could cause a short.

Plastic screw anchors for masonry if required. (Not supplied)

Conduit
(Shown inside wall)

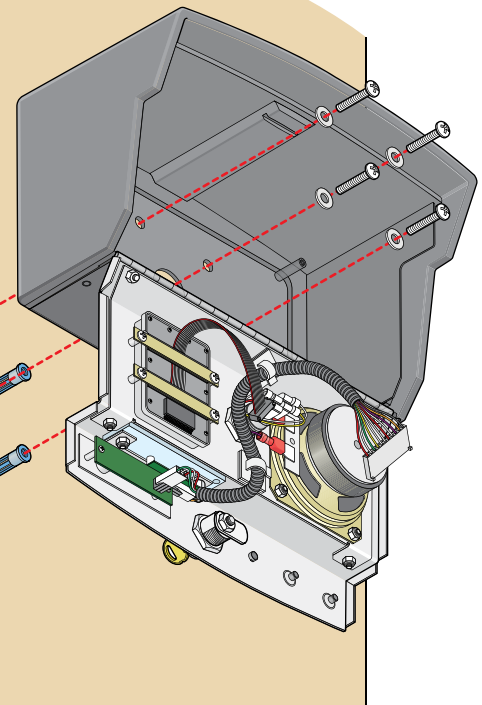

Flush Mount in a Pilaster, Wall or Kiosk

Mount rough-in box into the pilaster, wall or kiosk. Run conduit inside wall into bottom of rough-in box if desired. Use appropriate hardware (Not supplied) to secure the rough-in box in place.

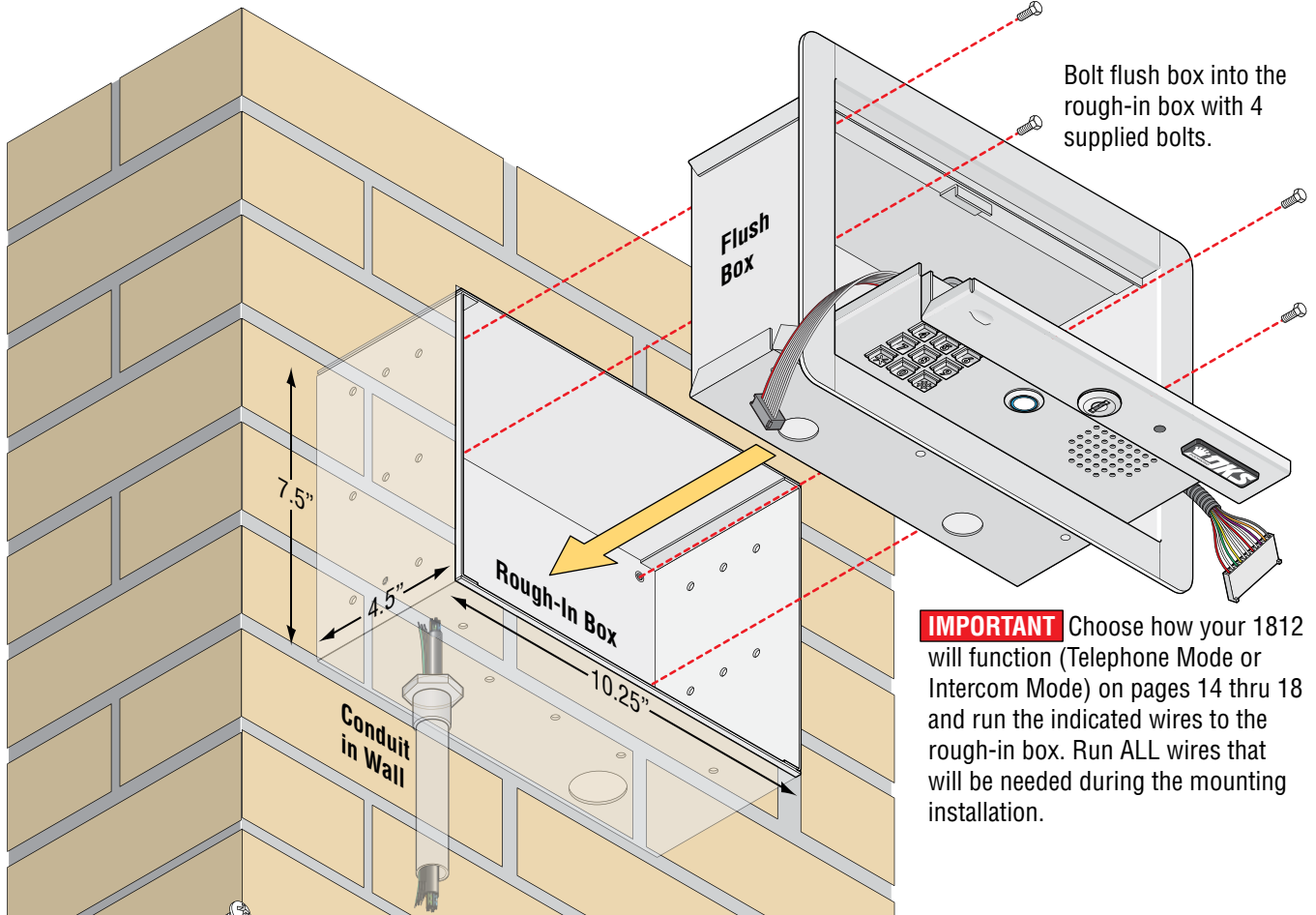

Bolt flush box into the rough-in box with 4 supplied bolts.

IMPORTANT Choose how your 1812 will function (Telephone Mode or Intercom Mode) on pages 14 thru 18 and run the indicated wires to the rough-in box. Run ALL wires that will be needed during the mounting installation.

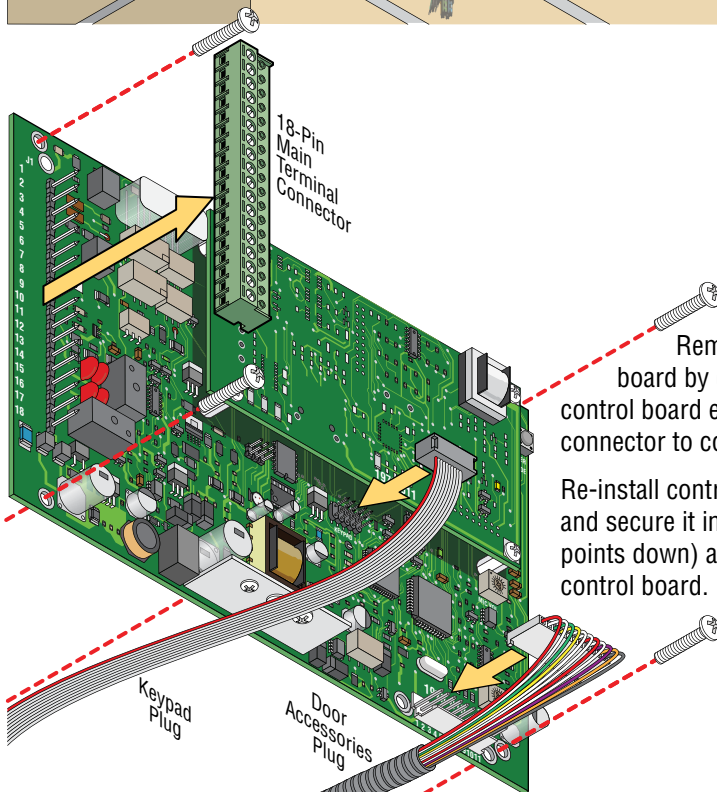

Re-install the Control Board

CAUTION The control board contains static sensitive components. Discharge any static electricity from your hands by touching a proper ground device **before** re-installing the control board. Also make sure that all dirt, metal or wood debris is removed from inside before re-installing the board.

Remove the 18-pin main terminal connector from the control board by **gently** pulling it straight up. This will make wiring to the control board easier. Note the orientation and numbering sequence of the connector to correctly wire it.

Re-install control board by **carefully** routing all incoming wires around it and secure it in place with 4 screws. Re-connect the keypad plug (cable points down) and door accessories plug (red wire goes to the left) to the control board.

Connect all wires to the 18-pin connector (See page 18). **Gently** re-connect it back on the control board. **DO NOT APPLY POWER** to the 1812 at this time.

1.2 Install By-Pass Board for “Telephone Mode” Configurations

The 1812’s by-pass board provides a method to by-pass the 1812 and route the incoming telephone line directly to the homeowner’s phone. **The By-Pass board IS NOT optional when using an incoming telephone line or internet (Telephone Mode) – it must be installed as part of the 1812 system. All telephone wires for the 1812 must pass through the by-pass board.** Wire the by-pass board either for a “Single 1812 - telephone mode” pages 14-15 or “Multiple 1812s - telephone mode” page 16.

Mount the by-pass board in a location that is easily accessible by the homeowner. In case of 1812 trouble or maintenance, the homeowner will use the by-pass switch on the board to route the incoming telephone line directly to their home phone. If the by-pass board is installed outdoors, it must be installed in a NEMA Type 4 enclosure (not supplied) to protect the board from direct exposure to landscape sprinklers, rain, snow and other elements.

“Entry” switch position:

Routes incoming phone line through 1812 and then to the home phone.

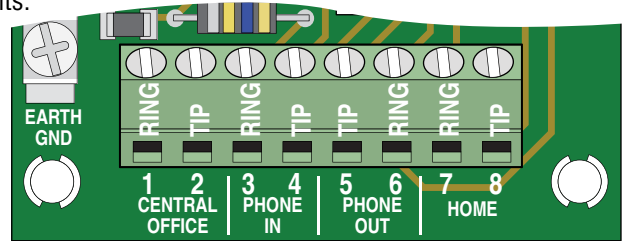
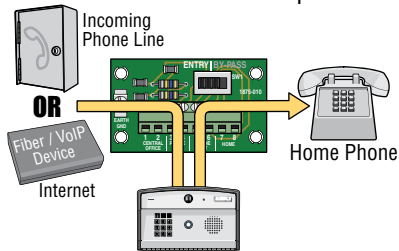

“Tip” and “Ring” Configuration

“By-Pass” switch position:

Routes incoming phone line directly to the home phone, bypassing 1812.

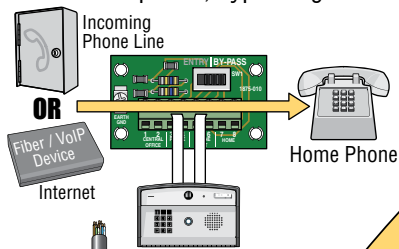

Four (4) mounting screws supplied.

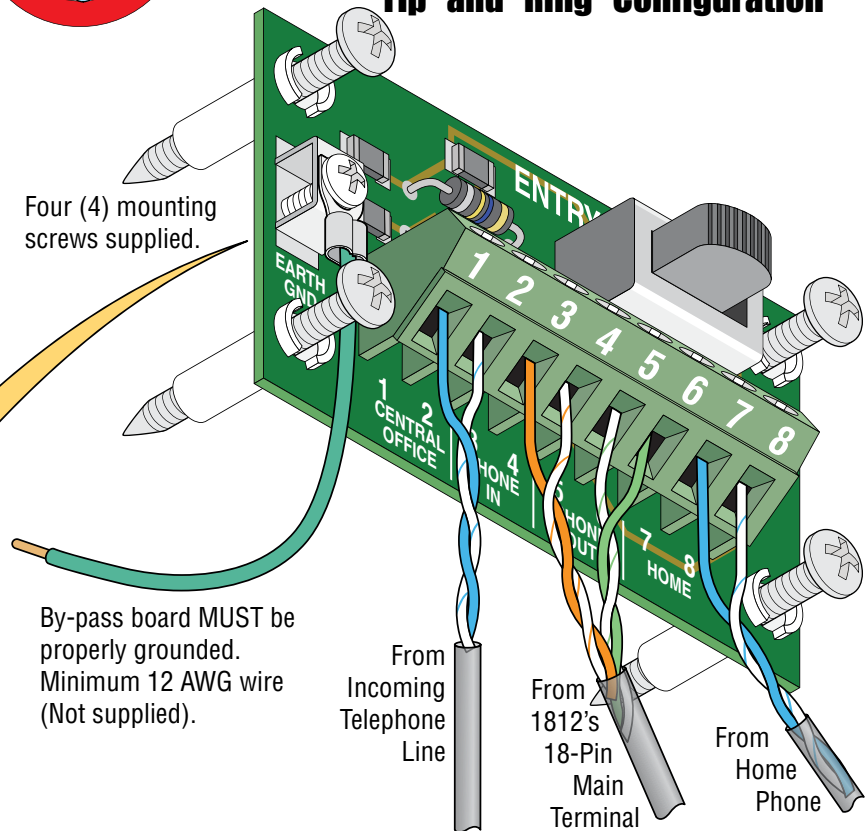

By-pass board **MUST** be properly grounded. Minimum 12 AWG wire (Not supplied).

If installed outdoors.

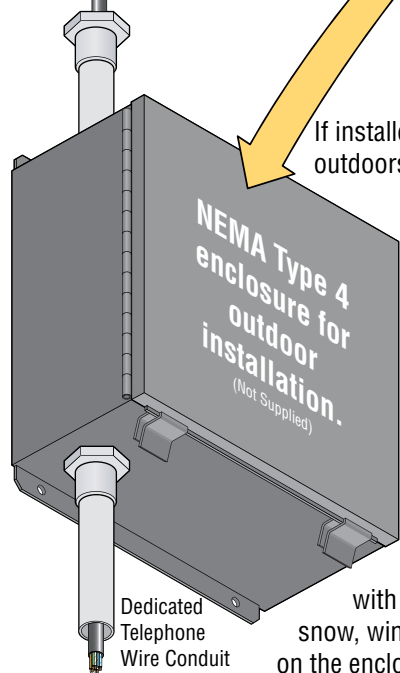

Use only twisted pair telephone wire that is rated for direct underground burial. **DO NOT** use wire that is intended for indoor applications. **Recommend Cat5e Gel Filled (flooded) UV Resistant Direct Burial Cable in conduit.** **DO NOT** run telephone wires and high voltage wires in the same conduit. It is recommended to run all necessary wires to the by-pass board in a “dedicated” telephone wire conduit. Check the phone wire chart on next page for wire size and distances.

National Electrical Manufacturers’ Association (NEMA) - Type 4 - Enclosure constructed for outdoor use to provide a degree of protection to personnel against incidental contact with the enclosed equipment: to provide a degree of protection against falling dirt, rain, sleet, snow, windblown dust, splashing water, and that will be undamaged by the external formation of ice on the enclosure.

1.3 Telephone Line Wire

Be sure to observe electrical safety when working with phone lines. Phone lines carry electricity and the ring voltage can deliver a substantial jolt. The best policy is to disconnect the house phone from the phone company Network Interface Device (also known as ‘Demarcation Device’) before working on the wiring.

In most residential homes, the phone cable contains four wires; green, red, black, yellow. The green and red are twisted to make one pair and the black and yellow are twisted to make another pair (This allowed for the addition of a second phone line since telephones use only two wires). Most phone lines installed in the U.S. in the second half of the 20th Century have this type of wire. This type of wire is now obsolete. All new telephone projects are using Cat5 wire. If you have Cat5 wiring in your home, the conversion is simple:

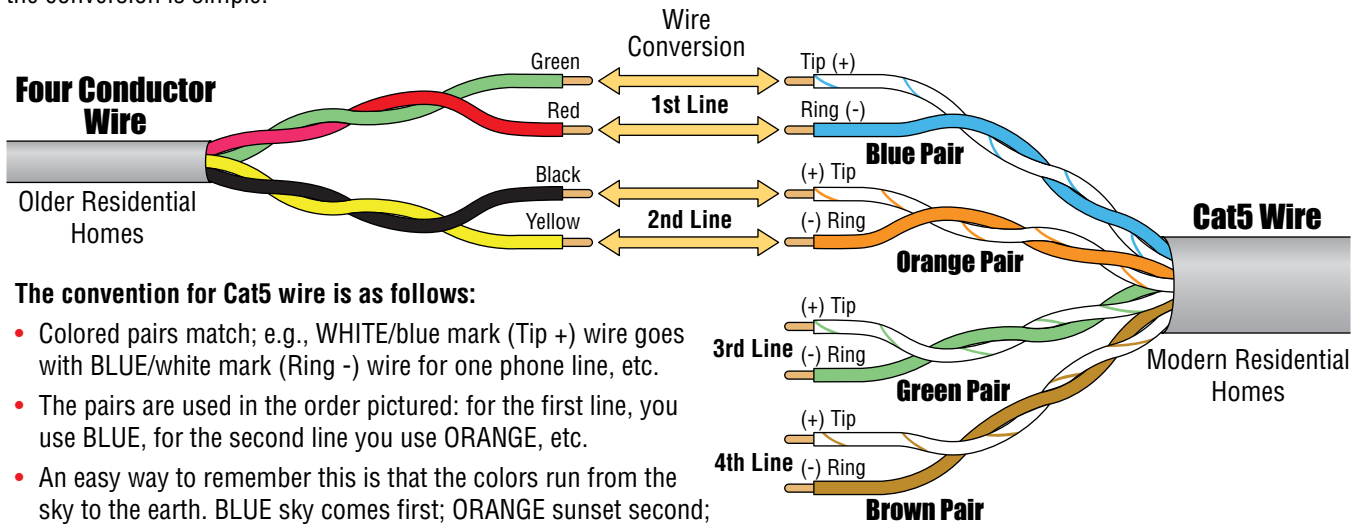

The convention for Cat5 wire is as follows:

- Colored pairs match; e.g., WHITE/blue mark (Tip +) wire goes with BLUE/white mark (Ring -) wire for one phone line, etc.
- The pairs are used in the order pictured: for the first line, you use BLUE, for the second line you use ORANGE, etc.
- An easy way to remember this is that the colors run from the sky to the earth. BLUE sky comes first; ORANGE sunset second; GREEN grass third; BROWN earth last.

“Tip” and “Ring” Definition. Common terms in the telephone service industry referring to the two wires or sides of an ordinary telephone line. Tip is the ground side (positive) and Ring is the battery (negative) side of a phone circuit. The ground side is common with the central office of the telephone company (telco); the battery side carries -48 volts of DC voltage when in an “Idle” or “On Hook” state.

Phone Line Polarity. Tip and ring reversal is mostly immaterial, except for special circuits including DID (Direct Inward Dialing) trunks, T-1 lines, and ground start lines where the field side (“terminal”) equipment (a company’s PBX switch, for example) can only function correctly with correct tip and ring polarity.

Wire Type. It is extremely important to use the correct type of wire in telephone applications. Since the 1812 requires phone lines to be run outdoors or in an underground environment, **we recommend that you use only wire that is rated for direct underground burial.** For example, **use Cat5e Gel Filled (flooded) UV Resistant Direct Burial Cable run in conduit for your 1812 phone line requirements.** Do not use thinly insulated brown-jacketed telephone wire (the type found in the walls of a house) for outdoor or underground phone line wiring. Using **improper wire can cause noise and hum** on the phone line. Be sure that phone wire pairs are twisted.

Wire Size and Distance. Phone lines can be run up to 3600 feet, provided that the proper wire size is used.

Wire Size	Max Distance
24 AWG	800 ft
22 AWG	1600 ft
20 AWG	2200 ft
18 AWG	3600 ft

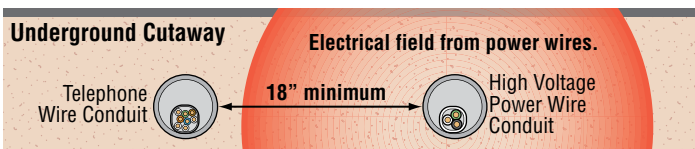

Note: Do not run telephone wires and high voltage power wires in the same conduit. Separate the high voltage conduit and the telephone conduit by at least 18 inches to prevent any electrical field interference that could occur.

1.4 16.5 VAC Power Wiring ONLY!

The 1812 Plus operates **ONLY** on 16.5 VAC. **DO NOT** power the 1812 with 24 volt AC power. Use the supplied power transformer, 16 VAC, 20 VA (or U.L. listed equivalent) to power the telephone entry system. **DO NOT** power any other devices (electric strikes, magnetic locks, etc.) from the 1812's power transformer. See table below for wire run distances.

Power Transformer Wire Run Table

Wire Size	Max Distance
18 AWG	100 ft
16 AWG	200 ft

CAUTION

DO NOT power the 1812 from a 24-Volt source (Such as a gate operator). **Damage will occur to the 1812** that is **NOT** covered under DoorKing's warranty.

Over Voltage Power Note: LED located on bottom left corner of board will light up if too much power is applied to circuit board.

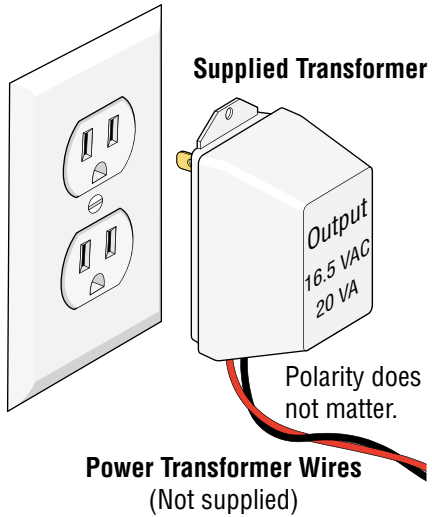

Power Interruption Note: The Time and Date calendar chip (Section 2, 2.6.1) in the 1812 Plus will keep time for approximately 48 hours if power to the system is lost or removed. If power is off **longer** than this, the **Time and Date will need to be reprogrammed into the system.** All other specific programming that has been done will remain intact after power has been restored.

DoorKing offers a **12 volt .8 amp hour gel cell battery** that can connect to the main terminals 9 and 10 to provide back-up power during power interruptions. (DoorKing P/N 1801-008)

1.5 Grounding and Surge Suppression

Proper Grounding and the use of surge suppressors can significantly reduce the chance of component failure because of static charges or surges. To be effective, ground connections should be made with a minimum 12 AWG wire to a ground point within 10 feet of the device being protected. The ground point can be at an electrical panel, a metallic cold water pipe that runs in the earth or a grounding rod driven at least 10 feet into the soil. **A gooseneck mounting post anchored in concrete does NOT make a good ground.**

Some Acceptable Ground Sources

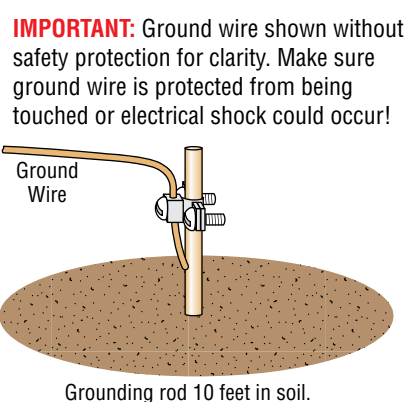
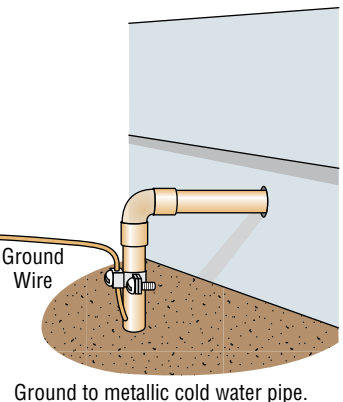
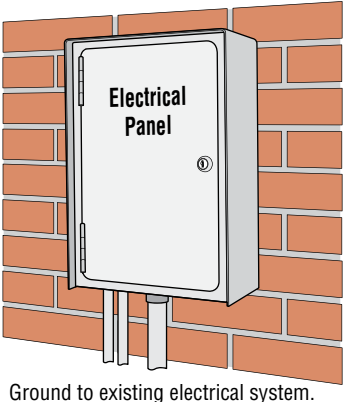

IMPORTANT: Ground wire shown without safety protection for clarity. Make sure ground wire is protected from being touched or electrical shock could occur!

Telephone Line Surge Suppressor

It is highly recommended that telephone line surge suppressor (DoorKing P/N 1877-010) be installed to help protect the system from phone line power surges. Surge suppressor must be positioned 3 ft or less from the ground source, 12 AWG min.

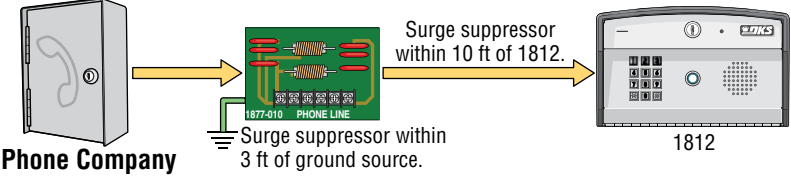

Low Voltage Surge Suppressor

It is highly recommended that a low voltage surge suppressor (DoorKing P/N 1878-010) be installed to help protect the telephone entry system from power surges. Surge suppressor must be positioned 3 ft or less from the ground source, 12 AWG min.

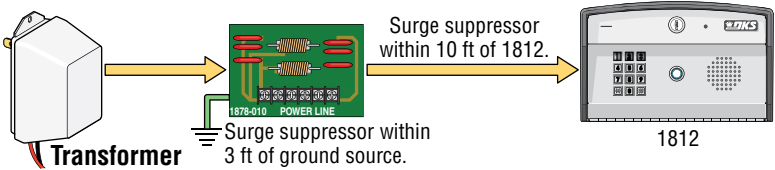

1.6 Wire One 1812 to a Telco Line - Telephone Mode

⚠️ Connect to Incoming Telephone Company's Phone Line

Locate the telephone company demarcation device. **IMPORTANT** Identify the wires that connect to the homeowner's telephone. Disconnect these 2 wires from the demarcation device and connect them to terminals #7 and #8 HOME on the by-pass board.

Connect a new twisted-pair telephone wire to the telephone company demarcation device where the 2 wires were just removed from. Connect the other end of the new twisted-pair wire to CENTRAL OFFICE terminals #1 and #2 on the by-pass board (Unless using a surge suppressor, then wire to surge board first).

Place the by-pass switch in the "By-Pass" position until the 1812 installation is complete. Test the homeowner's telephone. It should have a dial tone while the switch is in the "By-Pass" position. **See page 11.**

Telephone Company Demarcation Point

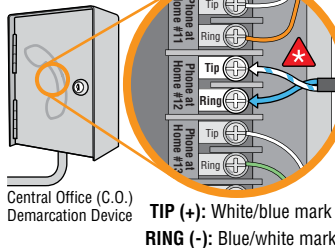

Phone Line Surge Suppressor

DoorKing Surge Suppressor P/N 1877-010 (or equivalent) is optional but highly recommended. For best protection, surge suppressor ground wire **MUST** be 3-ft. or less in length. Use minimum 12 AWG wire. **Refer to instruction sheet included with surge board for complete information.**

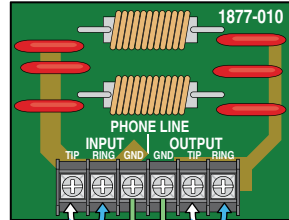

By-Pass Board

The By-Pass board is **NOT** optional and must be installed as part of the 1812 "Telephone Mode" system.

See page 11 for complete information.

Single 1812:
PHONE IN #3 connects to Main Term #1.
PHONE IN #4 connects to Main Term #2.
PHONE OUT #5 connects to Main Term #5.
PHONE OUT #6 connects to Main Term #4.

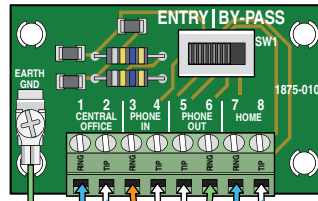

⚠️ Check Polarity of Telephone Line

Check for polarity on the incoming telephone line to each board and maintain polarity throughout the telephone line. One potential problem checked when a malfunction occurs in a telephone entry system is to see if the telephone line has been wired to each board with the correct polarity.

Test Example: By-pass board's CENTRAL OFFICE terminals #1 and #2. Terminal #2 must be positive (Tip +) with respect to terminal #1 (Ring -). Set a VOM meter to measure DC volts. Place the positive lead on terminal #2 and the negative lead on terminal #1. **If the meter shows a positive voltage - OK.** If the meter shows a negative voltage (needle moves off scale to the left), reverse the wires on terminals #1 and #2.

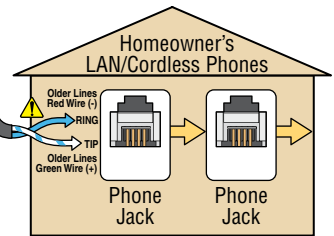

"Existing" Alarm System Location

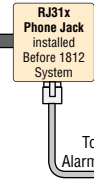

Be sure to properly ground **ALL** boards. **See previous page for acceptable grounding sources.**

Single 1812 Wiring Configuration

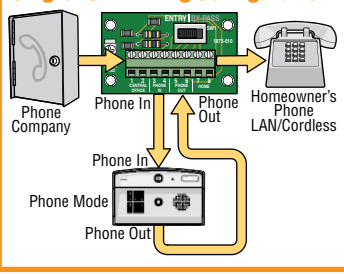

Access Control Devices

"Normally Open" Vehicular Gate Operator

Use minimum 18 AWG wire for runs up to 100 feet. 16 AWG wire for runs up to 200 feet. (Term. 11 and 13)



Pedestrian Gate/Door

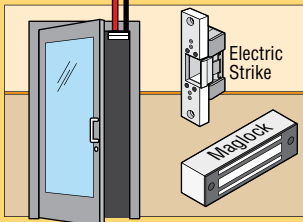

"Normally Close" with Maglock (Terminal 15 and 16)

"Normally Open" with Electric Strike (Terminal 14 and 16)

Magnetic locks or electric strikes must be powered from a separate UL Listed power transformer. **DO NOT** power strikes or magnetic locks from the 1812 power transformer. Use minimum 18 AWG wire for runs up to 100 feet; 16 AWG wire for runs up to 200 feet. It is recommended to keep power wire runs as short as possible.

Supplied Transformer

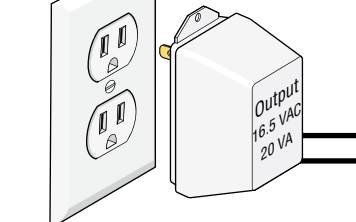

The 1812 Plus operates **ONLY** on 16.5 VAC. **DO NOT** power the 1812 with 24 Volt transformer or source voltage. Use the supplied power transformer, 16.5 VAC, 20 VA (or UL listed equivalent) to power the telephone entry system. **DO NOT** power any other devices (electric strikes, magnetic locks, additional 1812s etc.) from the 1812's power transformer. **See previous page for wire size and run distances.**

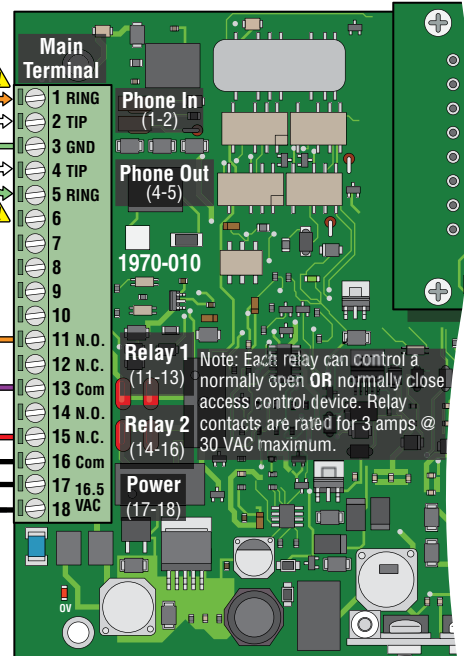

Low Voltage Surge Suppressor

DoorKing Surge Suppressor P/N 1878-010 (or equivalent) is optional but highly recommended. For best protection, surge suppressor ground wire **MUST** be 3-ft. or less in length. Use minimum 12 AWG wire. **Refer to instruction sheet included with surge board for complete information.**

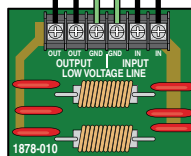

1.7 Wire One 1812 to the Internet - Telephone Mode

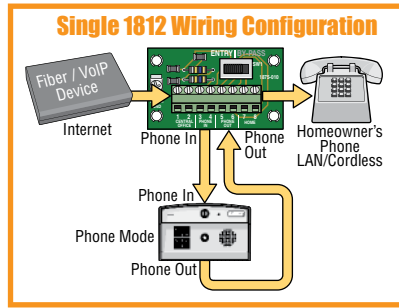
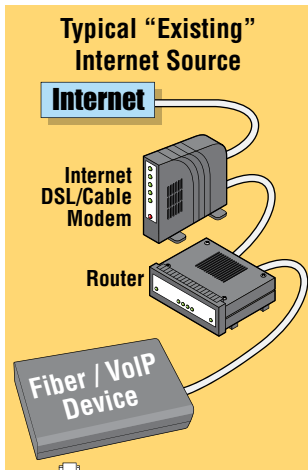

By-Pass Board
The By-Pass board is NOT optional and must be installed as part of the 1812 "Telephone Mode" system.
See page 11 for complete information.
Single 1812:
PHONE IN #3 connects to Main Term #1.
PHONE IN #4 connects to Main Term #2.
PHONE OUT #5 connects to Main Term #5.
PHONE OUT #6 connects to Main Term #4.

Check Polarity of Telephone Line
Check for polarity on the incoming telephone line to each board and maintain polarity throughout the telephone line. One potential problem checked when a malfunction occurs in a telephone entry system is to see if the telephone line has been wired to each board with the correct polarity.

Test Example: By-pass board's CENTRAL OFFICE terminals #1 and #2. Terminal #2 must be positive (Tip +) with respect to terminal #1 (Ring -). Set a VOM meter to measure DC volts. Place the positive lead on terminal #2 and the negative lead on terminal #1. **If the meter shows a positive voltage - OK.** If the meter shows a negative voltage (needle moves off scale to the left), reverse the wires on terminals #1 and #2.

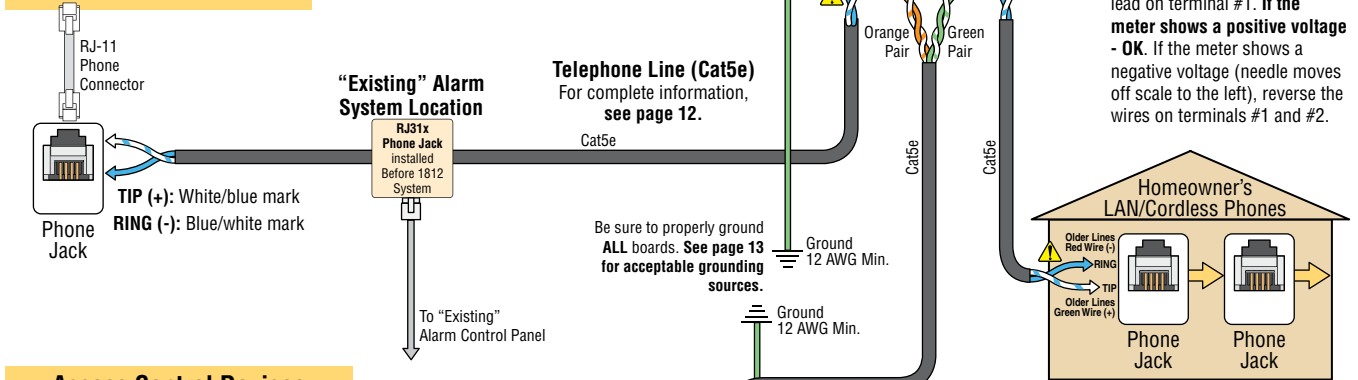

Access Control Devices

"Normally Open" Vehicular Gate Operator
Use minimum 18 AWG wire for runs up to 100 feet.
16 AWG wire for runs up to 200 feet. (Term. 11 and 13)

Pedestrian Gate/Door

Separate UL Listed Power Transformer

Electric Strike

Maglock

"Normally Close" with Maglock
(Terminal 15 and 16)

"Normally Open" with Electric Strike
(Terminal 14 and 16)

Magnetic locks or electric strikes must be powered from a separate UL Listed power transformer. **DO NOT** power strikes or magnetic locks from the 1812 power transformer. Use minimum 18 AWG wire for runs up to 100 feet; 16 AWG wire for runs up to 200 feet. It is recommended to keep power wire runs as short as possible.

Supplied Transformer
Polarity does not matter.

Output 16.5 VAC 20 VA

The 1812 Plus operates ONLY on 16.5 VAC. **DO NOT** power the 1812 with 24 Volt transformer or source voltage. Use the supplied power transformer, 16.5 VAC, 20 VA (or UL listed equivalent) to power the telephone entry system. **DO NOT** power any other devices (electric strikes, magnetic locks, additional 1812s etc.) from the 1812's power transformer. **See page 13 for wire size and run distances.**

Main Terminal

1 RING
2 TIP
3 GND
4 TIP
5 RING
6
7
8
9
10
11 N.O.
12 N.C.
13 Com
14 N.O.
15 N.C.
16 Com
17 16.5 VAC
18 VAC

Phone In (1-2)

Phone Out (4-5)

1970-010

Relay 1 (11-13)

Relay 2 (14-16)

Power (17-18)

Note: Each relay can control a normally open OR normally close access control device. Relay contacts are rated for 3 amps @ 30 VAC maximum.

Low Voltage Surge Suppressor
DoorKing Surge Suppressor P/N 1878-010 (or equivalent) is optional but highly recommended. For best protection, surge suppressor ground wire **MUST** be 3-ft. or less in length. Use minimum 12 AWG wire. Refer to instruction sheet included with surge board for complete information.

Recommended

Recommended

Ground 12 AWG Min. Within 3 ft of Surge Board

1878-010

1.8 Wire Multiple 1812s: Telco/Internet - Telephone Mode

Use the previous 2 page's wiring diagrams and information to wire multiple 1812s **except** for the By-Pass board's "PHONE IN" and "PHONE OUT" terminal connections. **Up to five (5) 1812s may be wired in series** to the By-Pass board using the method shown on this page: 1st 1812's PHONE OUT to 2nd 1812's PHONE IN; 2nd 1812's PHONE OUT to 3rd 1812's PHONE IN, etc. Connect the last 1812's PHONE OUT back to By-Pass board's PHONE OUT.

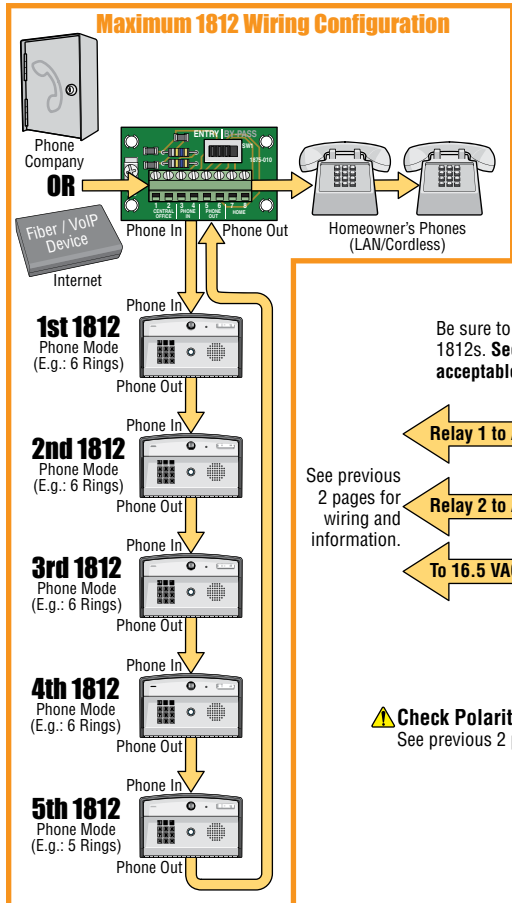

Note: **Each** 1812 must be programmed for MULTIPLE SYSTEMS, have a unique ATTENTION NUMBER (See 2.3.2 and 2.3.3) and have a unique MASTER CODE (See 2.2).

Note: The **LAST** 1812 wired in the series must have its "Number of Rings" programmed for **1 LESS** than any other of the 1812s in the series (See 2.3.9).

See previous 2 pages for wiring and information.

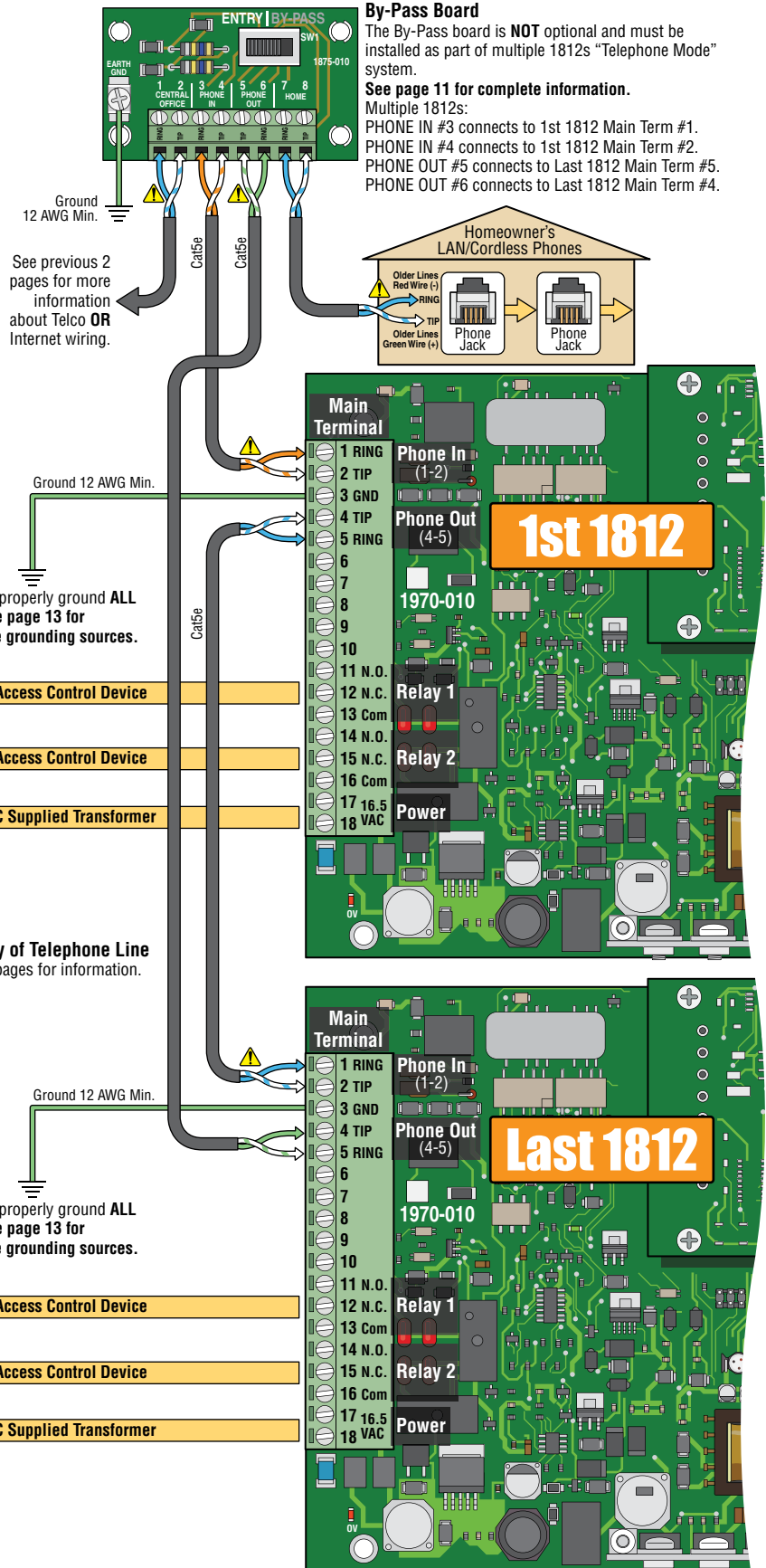

1.9 Wiring One 1812 - Intercom Mode

Connect to Homeowner's Telephone

When connecting directly to a single telephone or an un-used C.O. port on a PBX or KSU system, use the PHONE OUT terminals only in the 1812. It must be programmed for INTERCOM mode using this configuration.

When the 1812 is programmed for intercom mode, it provides the constant source of DC voltage necessary for communication. The intercom mode also disconnects the "PHONE IN" terminals (1 and 2) since they are not used.

Be sure that the 1812 is programmed in the intercom mode.

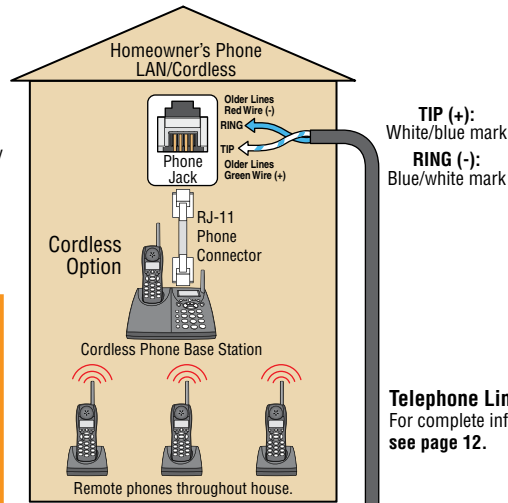

TIP (+):
White/blue mark
RING (-):
Blue/white mark

Telephone Line
For complete information, see page 12.

Wireless Adapter

DO NOT wire the wireless adapter to the PHONE OUT main terminal connection. Please refer to the "Wireless Adapter" manual 1815-560 for correct wiring.

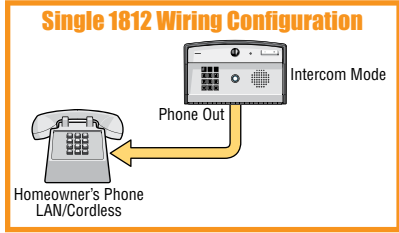

Access Control Devices

"Normally Open" Vehicular Gate Operator

Use minimum 18 AWG wire for runs up to 100 feet. 16 AWG wire for runs up to 200 feet. (Term. 11 and 13)

Pedestrian Gate/Door

Separate UL Listed Power Transformer

Electric Strike

Maglock

"Normally Close" with Maglock
(Terminal 15 and 16)

"Normally Open" with Electric Strike
(Terminal 14 and 16)

Magnetic locks or electric strikes must be powered from a separate UL Listed power transformer. **DO NOT** power strikes or magnetic locks from the 1812 power transformer. Use minimum 18 AWG wire for runs up to 100 feet; 16 AWG wire for runs up to 200 feet. It is recommended to keep power wire runs as short as possible.

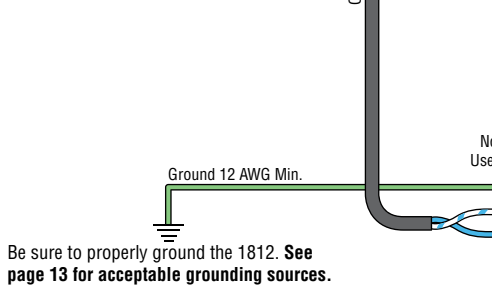

Supplied Transformer
Output 16.5 VAC 20 VA
Polarity does not matter.

The 1812 Plus operates **ONLY** on 16.5 VAC. **DO NOT** power the 1812 with 24 Volt transformer or source voltage. Use the supplied power transformer, 16.5 VAC, 20 VA (or UL listed equivalent) to power the telephone entry system. **DO NOT** power any other devices (electric strikes, magnetic locks, additional 1812s etc.) from the 1812's power transformer. See page 13 for wire size and run distances.

Low Voltage Surge Suppressor
DoorKing Surge Suppressor P/N 1878-010 (or equivalent) is optional but highly recommended. For best protection, surge suppressor ground wire **MUST** be 3-ft. or less in length. Use minimum 12 AWG wire. Refer to instruction sheet included with surge board for complete information.

Be sure to properly ground the surge suppressor. See page 13 for acceptable grounding sources.

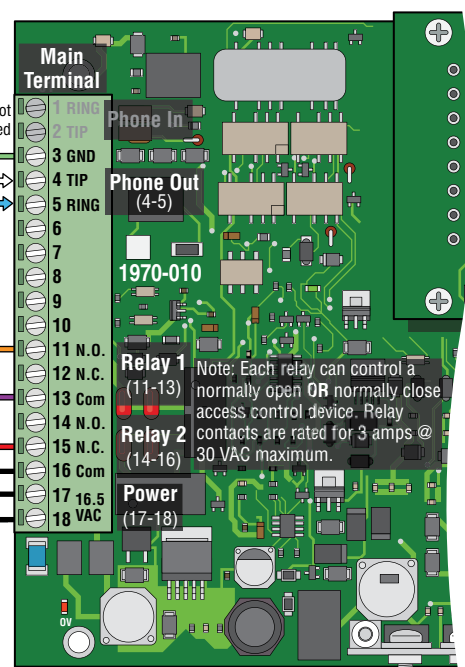

1.10 Wiring Multiple 1812s - Intercom Mode

Up to five (5) 1812s may be wired in series using the method shown: 1st 1812's PHONE IN to 2nd 1812's PHONE OUT; 2nd 1812's PHONE IN to 3rd 1812's PHONE OUT, etc. Each 1812 must have a unique ATTENTION NUMBER (See 2.3.3) and a unique MASTER CODE (See 2.2). The 1812 that is the furthest away from the phone or PBX / KSU system must be programmed for INTERCOM MODE. All other 1812 units in the series are programmed for TELEPHONE MODE (See 2.3.1).

Connect to Homeowner's Telephone

Connect the 1st 1812's PHONE OUT terminals directly to homeowner's phone or an un-used C.O. port on a PBX or KSU system.

⚠ Check Polarity of Telephone Line

Check for polarity on the incoming telephone line to each 1812 board and maintain polarity throughout the telephone line to the homeowner's phone. One potential problem checked when a malfunction occurs in a telephone entry system is to see if the telephone line has been wired to each board with the correct polarity.

Test Example: 1st 1812 board's PHONE IN terminals #1 and #2. Terminal #2 must be positive (Tip +) with respect to terminal #1 (Ring -). Set a VOM meter to measure DC volts. Place the positive lead on terminal #2 and the negative lead on terminal #1. If the meter shows a positive voltage - OK. If the meter shows a negative voltage (needle moves off scale to the left), reverse the wires on terminals #1 and #2.

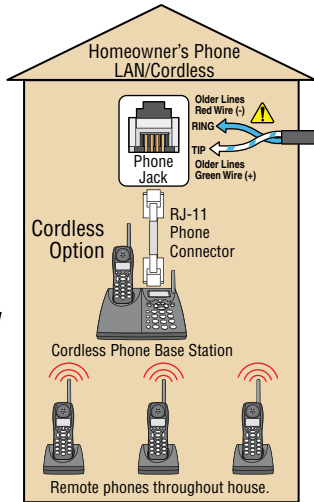

TIP (+):
White/blue mark
RING (-):
Blue/white mark

Telephone Line
For complete information, see page 12.

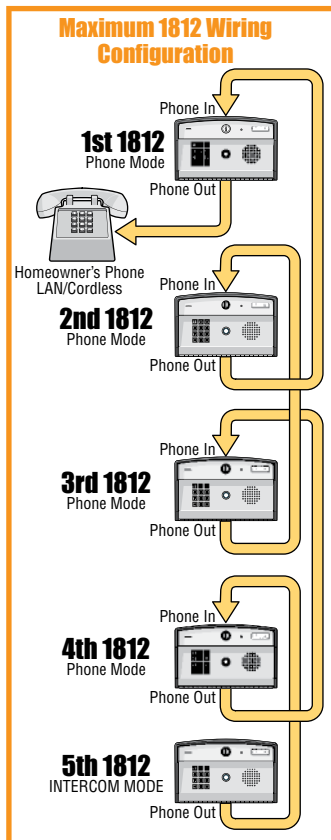

Be sure to properly ground ALL 1812s. See page 13 for acceptable grounding sources.

- ← Relay 1 to Access Control Device
- ← Relay 2 to Access Control Device
- ← To 16.5 VAC Supplied Transformer

- ← Relay 1 to Access Control Device
- ← Relay 2 to Access Control Device
- ← To 16.5 VAC Supplied Transformer

⚠ When multiple 1812 systems are connected together, maintain common polarity on ALL phone lines.

To the next 1812's PHONE OUT terminals 4 and 5 wired in the series, if desired.

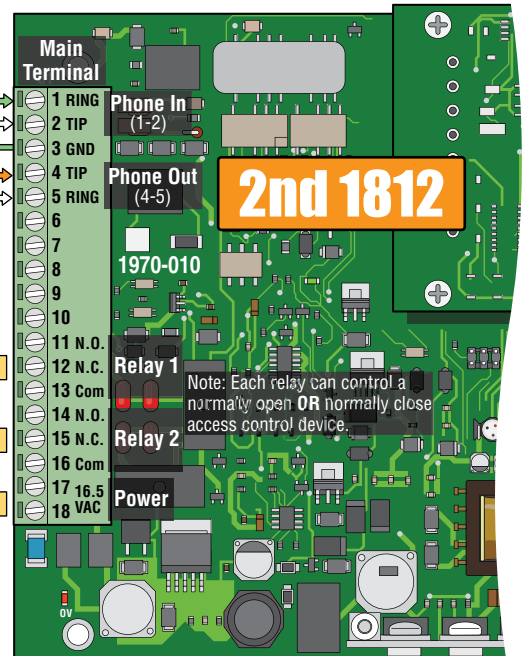
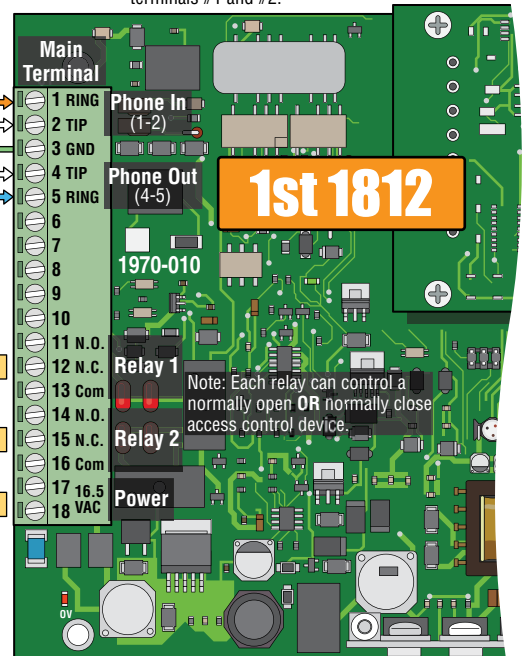

Wireless Adapter
DO NOT wire the wireless adapter to the PHONE OUT main terminal connection. Please refer to the "Wireless Adapter" manual 1815-560 for correct wiring.

1.11 Main Terminal Description

- OR **Phone In** (Twisted Pair) 1. Phone In (Negative - Ring)
- Wireless Adapter** 2. Phone In (Positive - Tip)
- 3. Ground (Required)
- Phone Out** (Twisted Pair) 4. Phone Out (Positive - Tip)
- 5. Phone Out (Negative - Ring)
- 6. Not Used.
- Emergency and/or Postal Entry Switch** 7. Switch Input Relay 1. A switch closure across terminals 7 & 9 will activate relay 1 for its programmed strike time.
- 8. Switch Input Relay 2. A switch closure across terminals 8 & 9 will activate relay 2 for its programmed strike time.
- Back-Up Battery Power** 9. - 12 VDC Battery Negative. Also **Common** for terminals 7 & 8.
- 10. + 12 VDC Battery Positive.
- Relay 1** (Access Control Device) 11. Relay 1 Normally Open
- 12. Relay 1 Normally Closed
- 13. Relay 1 **Common**
- Relay 2** (Access Control Device) 14. Relay 2 Normally Open
- 15. Relay 2 Normally Closed
- 16. Relay 2 **Common**
- Input Power (Transformer)** 17. 16.5 VAC Input Power
- 18. 16.5 VAC Input Power

WARNING Maximum input voltage to terminals 9 and 10 is 14.5 Volts DC.

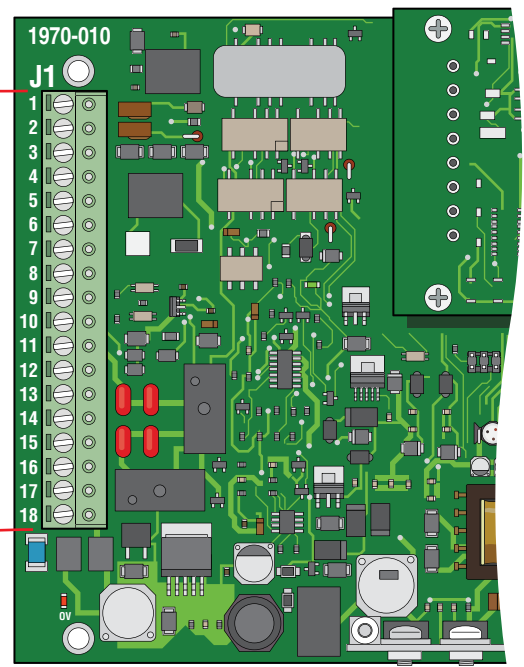

SECTION 2 - PROGRAMMING

Before You Start Programming: IMPORTANT! Make sure the 1812 has power and we strongly suggest that you become familiar with these programming instructions before beginning any programming of the 1812 Plus system.

The 1812 has been programmed at the factory with many of the programming parameters already set (default setting) for a typical residential application with a single 1812. There is no need to reprogram these parameters unless you want to change them. For easy reference, refer to the chart on page 22 that list the various programming functions and their default settings.

2.1 Programming Methods

The 1812 Plus can be programmed from the system keypad (Keypad on the 1812) or from a touch-tone telephone connected to the system.

Direct "System Keypad"

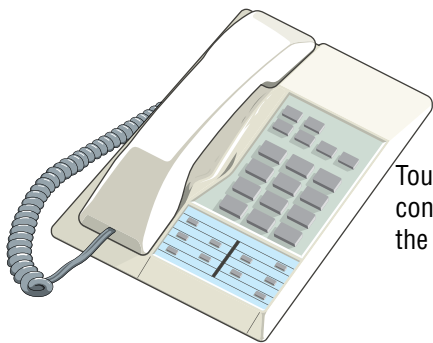
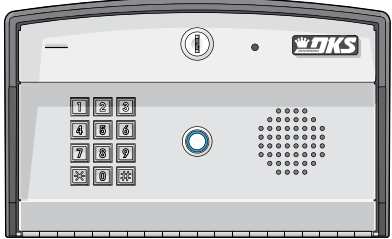

Touch-Tone Telephone connected directly to the system or off-site.

- **System Keypad (Preferred)**
We strongly recommend that you become familiar with the entire programming sequence before attempting to program some of the more complex features of this system using the system keypad. If you make a single error in the programming steps, you will have to re-do the sequence from the beginning.
- **Touch-Tone Telephone**
The programmable features that can be programmed using the system keypad can also be programmed using a touch-tone telephone (typically the house phone) connected to the 1812. This method of programming is useful for programming simple steps or for turning certain features ON or OFF, but is not recommended for complex programming steps.

2.2 Programming the Master Code

This programming step sets the system MASTER CODE. The master code is the four-digit number **REQUIRED** to gain access to the system memory.

The 1812 comes from the factory **WITHOUT** a master code programmed into it. **You MUST program a MASTER CODE.**

The Master Code can **ONLY** be programmed from the system keypad.



Step 1. Open the cabinet of the 1812 and press the master code button (See below). The **Blinking** LED right above the master code button will stop blinking and remain **ON**.

Note: After you press the master code push button, the blinking LED will stay **ON** indicating that you are in the master code programming sequence. If a master code is not entered within **10 seconds**, the master code program sequence will automatically end and the LED will return to a **blinking** state indicating that you have exited the master code programming sequence.

Step 2. Enter a four-digit master code then press *.



Actual keystrokes used on system keypad: ? ? ? ? Then * **“BEEP”**

Same keystrokes as written in this manual: [_ _ _ _ * (beep)]

Multiple 1812 Master Codes Note: The master code number is used to distinguish each 1812 when multiple 1812s are connected together. They **CAN NOT** function together with duplicate master codes.

Step 3. The LED will revert to **Blinking**. Close the cabinet. **You should write down your master code, see note below.**

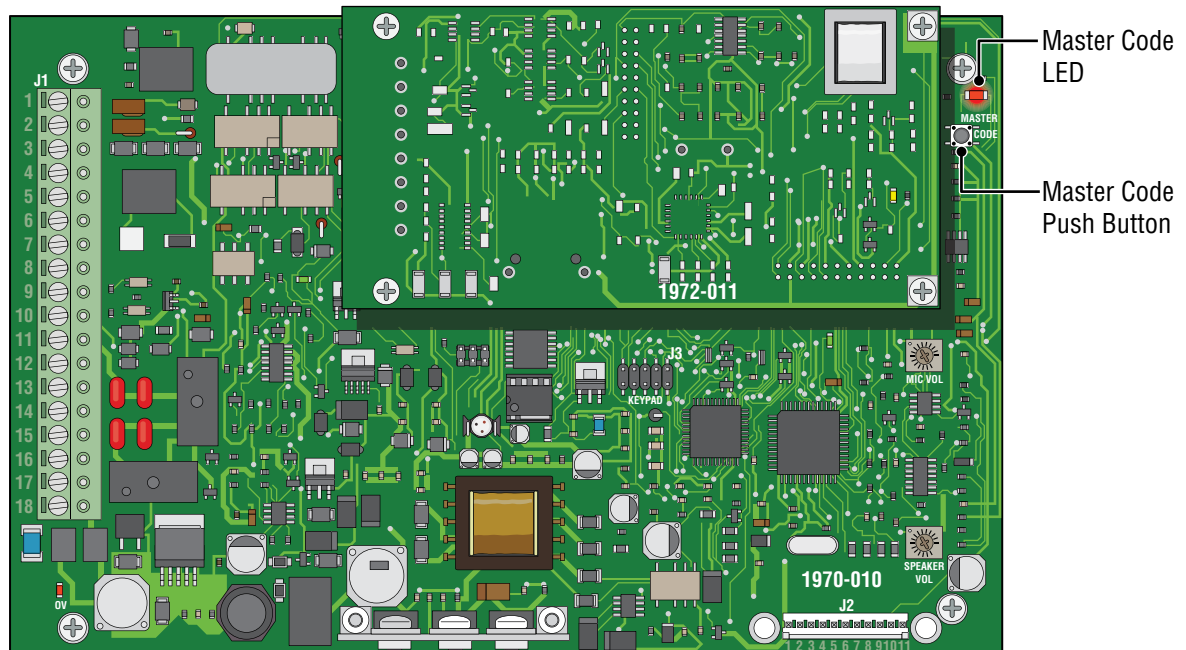

Programming Documentation Note: There are programming log sheets in the back of this manual to document your specific master code, and keep track of all other programming that is preformed to this 1812 Plus. Keep this with all other system documentation for future reference. **There is no way of retrieving the master code after it has been programmed in.** If you forget it, you will have to program in a new one but all other previously programmed information will remain intact.

2.3 System Parameters Programming

IMPORTANT! We strongly suggest that you read these programming instructions in their entirety before beginning any manual programming of the 1812 Plus system.

The programming table on the next page provides a quick reference to:

Programming from the System Keypad

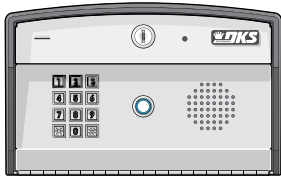

Follow the programming instructions as described in each section of this manual.

IMPORTANT The system will prompt you with short tones (**beep**) when programming steps have been correctly keyed in and with a long tone (**beeeeeep**) when all of the programming steps have been successfully completed in the sequence.

Programming from a Touch-Tone Telephone

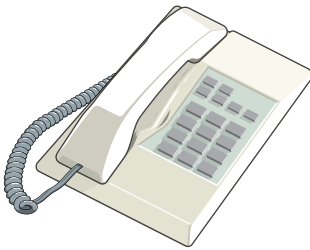

Homeowner's Touch-Tone Telephone

Follow these steps when programming the 1812 Plus from the **Homeowner's Touch-Tone Telephone**.

IMPORTANT The system will require an "ATTENTION NUMBER". The system attention number is the number that the **1812's programming mode** will respond to when called from the **Homeowner's Phone**. If more than one 1812 is sharing the phone line, be sure that each system's attention number is unique.

Note: The system attention number is **factory set to 7**. This can be changed to any number, and will have to be changed when using multiple systems on the same phone line, see section 2.3.3.

1. Press * and then the system ATTENTION NUMBER. [*** 7 (beep)**]
2. Follow the programming instructions as described in each section of this manual. The system will prompt you with short (beep) tones when programming steps have been followed correctly.
3. When complete, hang up. You cannot use 0# pressed together to end programming steps from a touch-tone telephone. Wait 30 seconds before calling back to program another feature.



Off-Site Touch-Tone Telephone

Follow these steps when programming the 1812 Plus from an **Off-Site Touch-Tone Telephone**.

IMPORTANT The 1812 must be programmed to answer incoming calls, section 2.3.9.

1. Call the resident telephone number. The 1812 will answer with a short beep after the programmed number of rings.
2. Follow the programming instructions as described in each section of this manual. The system will prompt you with short (beep) tones when programming steps have been followed correctly.
3. When complete, hang up. You cannot use 0# pressed together to end programming steps from a touch-tone telephone. Wait 30 seconds before calling back to program another feature.

Quick Reference Table

	Page #	Section	Command	Factory Settings
Section 2.3 System Parameters Programming				
Phone Mode or Intercom Mode	23	2.3.1	* 0 6	1 (Phone Mode)
Single or Multiple Systems	23	2.3.2	* 6 1	1 (Single System)
System Attention Number	23	2.3.3	* 6 2	7
Single or Double Ring	23	2.3.4	* 6 3	1 (Double Ring)
Number of Home Phone Rings Before 1812 Hangs Up	23	2.3.5	* 6 4	05 (5 Rings)
Talk Time	24	2.3.6	* 0 8	060 (60 Sec.)
Relay Strike Time	24	2.3.7	* 0 3	1 Sec
Tone Open Numbers	24	2.3.8	* 0 5	Relay 1: 9 8 7 6 Relay 2: 5 4 3 2
Answer Incoming Call on X Rings	25	2.3.9	* 1 8	06 (6 Rings)
Hang-up Tone Number	25	2.3.10	* 1 7	0
Call Waiting	25	2.3.11	* 2 0	1 (ON)
Turn Speaker On / Control Relay from Off-Site Call	25	2.3.12	* 1 6	N / A
Set Call Forwarding Microphone Gain & Speaker Volume	26	2.3.13	* 1 1	7 (Mic) 1 (Speaker)
Section 2.4 Directory Codes				
Directory Codes 24 – 50 Programming “Dial Phone Number”	26	2.4.1	* 4 1	Empty
Delete a Phone Number from Directory Codes 24 – 50	26	2.4.2	* 4 2	N / A
Delete All Phone Numbers from Directory Codes 24 – 50	26	2.4.3	* 4 3	N / A
Section 2.5 Access Codes to Operate Access Control Devices				
“Simple” Access Code Programming (24/7 Operation)	27	2.5.1	* 0 2	Empty
“Time Zone Restricted” Access Code Programming	27	2.5.2	* 7 0	Empty
Delete an Access Code (Simple and Time Zone Restricted)	27	2.5.3	* 7 1	N / A
Delete All Access Codes (Simple and Time Zone Restricted)	28	2.5.4	* 7 2	N / A
“Temporary” Access Codes Programming	28	2.5.5	* 7 3	Empty
Delete a “Temporary” Access Code	28	2.5.6	* 7 4	N / A
Delete All “Temporary” Access Codes	28	2.5.7	* 7 5	N / A
Section 2.6 Time Functions				
Time and Date Calendar Chip Programming	29	2.6.1	* 3 3	Empty
Call Forward Phone Number Programming	29	2.6.2	* 1 0	Empty
Call Forward - ON/OFF or Time Zone Activation	30	2.6.3	* 3 7	Empty
Do Not Disturb Time Zone Programming	30	2.6.4	* 3 4	Empty
Automatic Relay Activation Time Zone Programming (Up to 4)	31	2.6.5	* 3 5	Empty
Access Code Time Zone Programming (Up to 4)	31	2.6.6	* 3 6	Empty
Section 2.7 Miscellaneous				
Restore Factory Defaults	32	2.7.1	* 9 0	N / A

2.3.1 Phone Mode or Intercom Mode

Factory setting is 1 (Phone Mode).

The 1812 is normally connected in series with a resident's incoming phone line, which supplies a constant source of DC voltage. When the 1812 is connected in this manner, program the unit for PHONE mode.

If the 1812 is to be connected to an open C.O. (Central Office) port or through the internet on a key type telephone system.

If the 1812 is connected directly to a telephone without a C.O. or internet line, program the unit for INTERCOM mode. When programmed in intercom mode, the 1812 will supply the constant DC voltage necessary for operation and will disconnect the PH-IN terminals 1 and 2 from the circuit board since these are not used in intercom mode.

If the 1812 is programmed for the intercom mode, the call forwarding and preprogrammed dial-out phone number (Directory Codes) features **will not work**.

1. Press * 0 6 and enter the MASTER CODE. [*** 0 6** _ _ _ _ (beep)]
2. Press 1 * for phone mode **OR** press 0 * for intercom mode. [_ *****(beep)]
3. Press 0 # TOGETHER to end. [**0 #** (beeeeeep)]

2.3.2 Single or Multiple Systems

Factory setting is 1 (Single System).

Set for single if the 1812 is the only unit connected to the phone line, or set to multiple if more than one 1812 is connected to the phone line.

1. Press * 6 1 and enter the MASTER CODE. [*** 6 1** _ _ _ _ (beep)]
2. Press 1 * for a single system **OR** press 0 * for multiple systems. [_ *****(beep)]
3. Press 0 # TOGETHER to end. [**0 #** (beeeeeep)]

2.3.3 System Attention Number

Factory setting is 7.

The system attention number is the number that the 1812 responds to when called from the residence. If more than one 1812 is sharing the phone line, **be sure the attention number to each unit is programmed with a unique attention number.**

1. Press * 6 2 and enter the MASTER CODE. [*** 6 2** _ _ _ _ (beep)]
2. Enter a single digit attention number (0-9), then press *. [_ *****(beep)]
3. Press 0 # TOGETHER to end. [**0 #** (beeeeeep)]

2.3.4 Single or Double Ring

Factory setting is 1 (Double Ring).

Setting this for a double ring provides a unique ring so that a call from the 1812 is easily identified, or the ring can be set to the standard single long ring.

1. Press * 6 3 and enter the MASTER CODE. [*** 6 3** _ _ _ _ (beep)]
2. Press 1 * for a double ring **OR** press 0 * for a single ring. [_ *****(beep)]
3. Press 0 # TOGETHER to end. [**0 #** (beeeeeep)]

2.3.5 Number of Home Phone Rings Before 1812 Hangs Up

Factory setting is 05 (5 Rings).

When the CALL button on the 1812 is pushed, this programming sequence sets the number of unanswered rings to the homeowner's phone before the 1812 hangs up.

1. Press * 6 4 and enter the MASTER CODE. [*** 6 4** _ _ _ _ (beep)]
2. Enter the number of rings before 1812 hangs up (01-99), then press *. [_ _ *****(beep)]
3. Press 0 # TOGETHER to end. [**0 #** (beeeeeep)]

2.3.6 Talk Time

Factory setting is 060 (60 Seconds).

This programming sequence sets the maximum time allowed for conversation when the 1812 places a call to the resident's house, or if call forwarding is active, or if any of the dial out numbers are used. Talk time can be set from 10 seconds up to 255 seconds (4 minutes, 15 seconds) and is entered as a three-digit number. For example, to set a talk time of 30 seconds, enter 030 in step 2.

1. Press * 0 8 and enter the MASTER CODE. [*** 0 8** _ _ _ _ (beep)]
2. Enter the talk time code (010-255), then press *. [_ _ * (beep)]
3. Press 0 # TOGETHER to end. [**0 # (beeeeeep)**]

2.3.7 Relay Strike Time

Factory setting for Relays 1 and 2 is 01 (1 Second).

These steps will program the system relay strike times.

Relay strike times can be programmed from 1/4 second - enter 0 0 * in step 3, up to 99 seconds - enter 9 9 * in step 3. System relays 1 and 2 are the two relays on the 1812 main circuit board.

1. Press * 0 3 and enter the MASTER CODE. [*** 0 3** _ _ _ _ (beep)]
2. Enter a relay number (1 or 2), then press *. [_ * (beep)]
3. Enter the two-digit strike time (00-99), then press *. [_ _ * (beep)]
4. Repeat steps 2 and 3 to set the other relay strike time if necessary.
5. Press 0 # TOGETHER to end. [**0 # (beeeeeep)**]

2.3.8 Tone Open Numbers

Factory setting is 9876 for Relay 1; 5432 for Relay 2.

These steps will program the tone open number(s) for each relay in the system (each relay is programmed independently). You will need to enter a four-digit number (see chart below) to set each relay in step 3. If a function is not desired, enter # in place of the digit. Use a different number for each of the four-digits in step 3 when multiple functions are desired. Note: "Hold Open" and "Hold 1 hour" will not function when a call is made via dialing a directory number.

Example 1: If you want the relay to have a "momentary activation" function only, and you want it to activate when the number 9 is pressed, enter 9 # # # * in step 3.

Example 2: If you only want the relay to hold open when the number 8 is pressed and the relay deactivated when the number 7 is pressed, enter # 8 7 # * in step 3.

1. Press * 0 5 and enter the MASTER CODE. [*** 0 5** _ _ _ _ (beep)]
2. Enter a relay number (1 or 2), then press *. [_ * (beep)]
3. Choose and enter a four-digit tone open number code (see chart below), then press *. [_ _ _ _ * (beep)]
If a tone open function is not desired, enter # in place of a number.
4. Repeat steps 2 and 3 to set the other relay tone open number(s) if desired.
5. Press 0 # TOGETHER to end. [**0 # (beeeeeep)**]

4 Digit Tone Open Number Code	Function
1st Digit (Step 3)	Momentary activation. Relay will activate for its programmed relay strike time.
2nd Digit (Step 3)	Hold open (latch). Relay will activate and remain activated until commanded to deactivate.
3rd Digit (Step 3)	Deactivate relay.
4th Digit (Step 3)	Hold open 1 hour. Relay will activate for 1 hour and then deactivate itself.

2.3.9 Answer Incoming Call on X Rings

Factory setting is 06 (6 Rings).

This programming section sets the number of rings that the 1812 will allow to pass through the system before it picks up the call. The number of rings to answer can be set from 1 to 99 rings and must be entered as a two-digit number. For example, if you want the 1812 to answer the call after the sixth ring, enter 0 6 * in step 2. If you program 0 0 * in step 2, this will prevent (disable) the 1812 from answering incoming calls to it.

Important! If more than one 1812 is connected in the system (2.3.2 set for multiple systems), the **LAST** 1812 that is wired in the line must have the “Answer Incoming Call” set for **one less ring** than the other 1812 units connected.

1. Press * 1 8 and enter the MASTER CODE. [*** 1 8** _ _ _ _ (beep)]
2. Enter the number of rings (01-99), then press *. [_ _ *(beep)]
(enter 00 in this step to disable this feature)
3. Press 0 # TOGETHER to end. [**0 #** (beeeeeep)]

Example:

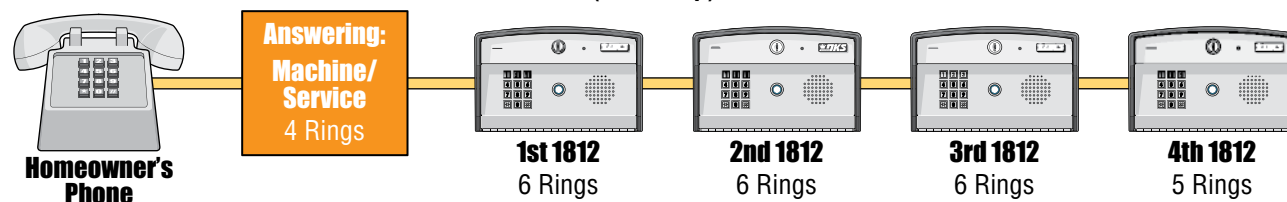

2.3.10 Hang Up Tone Number

Factory setting is 0.

These steps set the number that will hang-up the 1812 after the conversation is completed. The hang up tone is used when a call from the 1812 has been forwarded to an outside number. **Once the conversation has ended, the hang up tone number should be pressed;** otherwise the 1812 will remain on the line for a period of time.

1. Press * 1 7 and enter the MASTER CODE. [*** 1 7** _ _ _ _ (beep)]
2. Enter the hang up tone number (1-9), then press *. [_ *(beep)]
3. Press 0 # TOGETHER to end. [**0 #** (beeeeeep)]

2.3.11 Call Waiting

Factory setting is 1 (Call Waiting On).

These steps will turn the Call Waiting feature either ON or OFF. The call waiting feature will allow the resident to place an outside call on hold when a visitor presses the call button on the 1812. Once communication with the visitor is established, access can be granted or denied. If access is granted (press the number to open the door or gate), the 1812 will automatically switch the call back to the outside call. If the resident wants to deny access, they simply press the # key to switch back to the outside call.

1. Press * 2 0 and enter the MASTER CODE. [*** 2 0** _ _ _ _ (beep)]
2. Press 1 * to turn Call Waiting ON **OR** press 0 * to turn Call Waiting OFF. [_ *(beep)]
3. Press 0 # TOGETHER to end. [**0 #** (beeeeeep)]

2.3.12 Turn Speaker On / Control Relay from Off-Site Call

This command allows you to call the 1812 from a remote location and turn on the speaker at the unit to enable two-way voice communication and will allow relay control – all “Tone Open Numbers” that are programmed (2.3.8).

1. Call the resident’s phone number. After the programmed number of rings (2.3.9) the 1812 will answer with a tone.
2. Press * 1 6 and enter the MASTER CODE. [*** 1 6** _ _ _ _ (beep)]
If you use a “tone open number” during the call to activate a relay, the 1812 will automatically hang up after the “tone open number” is used. Only one activation number will function per phone call.
Example: If you call and want to “Hold Open” the relay, you will have to call back to “Deactivate” it later.
3. Hang up when your conversation is completed when NOT using a “tone open number”.

2.3.13 Set Call Forward Microphone Gain and Speaker Volume

Factory setting is 71 (7 - Microphone, 1 - Speaker).

This adjustment is required only if call forward or directory code dialing is being used. This step will adjust the microphone gain (the remote handset loudness) and the speaker volume (the 1812 loudness) during call forwarding operation. You may have to perform these steps several times to get the optimal microphone gain and speaker volume adjustment.

Be sure that you have a call forward phone number programmed (2.6.2) and call forwarding is turned on (2.6.3).

Before making any adjustments, do a test call as the programmed settings may work fine for you and no additional adjustments may be necessary. If adjustments are made, you will need to do a call forward test call after each adjustment to determine if the result is to your liking.

The valid values for both the microphone gain and speaker volume are 0 through 9. These values are entered as a two-digit number in step 2 below. The first digit is the microphone gain; the second digit is the speaker volume. The factory setting is 71, which means that the microphone gain is set to 7 and the speaker volume is set to 1. A higher value increases the loudness where as a lower value decreases the loudness.

1. Press * 1 1 and enter the MASTER CODE. [*** 1 1 _ _ _ _ (beep)**]
2. Enter a two-digit microphone gain and speaker loudness setting, then press *. [**_ _ *(beep)**]
3. Press 0 # TOGETHER to end. [**0 # (beeeeeep)**]

2.4 Directory Codes

2.4.1 Directory Codes 24 – 50 Programming “Dial Phone Number”

The 1812 has the capability of operating as an auto-dialer system and can store up to 27 phone numbers in its memory. When a visitor enters a directory code on the system keypad, the 1812 will call the phone number programmed under the specific directory code number. The directory codes, 24 through 50, cannot be revised after they have been programmed into the system memory, only deleted (see 2.4.2 below).

Note: This feature cannot be used if the 1812 is programmed in the intercom mode (see 2.3.1).

1. Press * 4 1 and enter the MASTER CODE. [*** 4 1 _ _ _ _ (beep)**]
2. Enter a two-digit directory code (24-50), then press *. [**_ _ *(beep)**]
3. Enter the phone number (up to 20 digits, no dashes), then press *. [**_ _ _ _ _ _ _ _ _ _ _ _ _ _ _ _ _ _ *(beep)**]
All 20 spaces do not have to be populated with numbers.
4. Repeat steps 2 and 3 to enter additional numbers.
5. Press 0 # TOGETHER to end. [**0 # (beeeeeep)**]

2.4.2 Delete a Phone Number from Directory Codes 24 – 50

This programming sequence deletes **individual** directory code dial-out phone numbers from the system memory.

1. Press * 4 2 and enter the MASTER CODE. [*** 4 2 _ _ _ _ (beep)**]
2. Enter a two-digit directory code (24-50) of the phone number you want to delete, then press *. [**_ _ *(beep)**]
3. Repeat step 2 to delete additional existing phone numbers.
4. Press 0 # TOGETHER to end. [**0 # (beeeeeep)**]

2.4.3 Delete ALL Phone Numbers from Directory Codes 24 – 50

This programming sequence will delete **ALL** directory code dial-out phone numbers from the system memory.

WARNING: once started, all phone numbers will be erased.

1. Press * 4 3 and enter the MASTER CODE. [*** 4 3 _ _ _ _ (beep)**]
2. Press 9 9 9 9, then press *. [**9 9 9 9 (beep)**]
3. The programming sequence will end itself automatically. [**beeeeeep**]

2.5 Access Codes to Operate Access Control Devices

2.5.1 “Simple” Access Code Programming (24/7 Operation)

This programming sequence programs “simple” access codes into the system memory. **“Simple” access codes cannot be time zone restricted**; they can **ONLY** be assigned to operate the 2 internal relays on a 24/7 basis using the relay strike time programmed in section 2.3.7. If you require the access codes to be “time zone restricted”, use the programming sequence in 2.5.2.

Note: Up to 50 access codes can be programmed into the system. This 50 includes “simple” access codes programmed in 2.5.1 **AND** access codes programmed in 2.5.2. For example, if 10 “simple” access codes are programmed in 2.5.1, then only 40 access codes can be programmed in 2.5.2.

1. Press * 0 2 and enter the MASTER CODE. [*** 0 2** _ _ _ _ (beep)]
2. Press 1 for relay 1 **OR** Press 2 for relay 2, then press *. [**_ ***(beep)]
3. Choose and enter a five-digit “simple” access code, then press *. [**_ _ _ _ _ ***(beep)]
4. Repeat steps 2 and 3 to enter additional “simple” access codes.
5. Press 0 # TOGETHER to end. [**0 #** (beeeeeep)]

2.5.2 “Time Zone Restricted” Access Code Programming

This programming sequence programs access codes into the system memory **with time zone restrictions applied**. It also allows programming of the **access codes to momentarily activate a relay or to hold open (latch) a relay**.

Note: Up to 50 access codes can be programmed into the system. This 50 includes the “simple” access codes programmed in 2.5.1 **AND** access codes programmed in 2.5.2. For example, if 10 “simple” access codes are programmed in 2.5.1, then only 40 access codes can be programmed in 2.5.2.

1. Press * 7 0 and enter the MASTER CODE. [*** 7 0** _ _ _ _ (beep)]
2. Press 2, then press *. [**2 ***(beep)]
3. Choose and enter a five-digit access code, then press *. [**_ _ _ _ _ ***(beep)]
4. Enter a minimum of 1, and a maximum of 4 time zones (valid time zones are 0 through 6) that you want to apply to this access code, then press *. [**_ _ _ _ ***(beep)]
Time zone 0 - Always deny access.
Time zone 1 - Allows 24/7 access for relay 1 **ONLY**.
Time zone 2 - Allows 24/7 access for relay 2 **ONLY**.
Time zones 3, 4, 5 and 6 - Are time zones that have been programmed in 2.6.6.
5. Enter 0 * for momentary relay activation or enter 1 * to hold open (latch) the relay. [**_ ***(beep)]
6. Repeat steps 2 through 5 to program additional access codes (Time zone restricted).
7. Press 0 # TOGETHER to end. [**0 #** (beeeeeep)]

2.5.3 Delete an Access Code (Simple and Time Zone Restricted)

This programming sequence deletes individual “simple” and “time zone restricted” access codes that have been programmed into the system. “temporary” access codes **CANNOT** be deleted. If you require a “temporary” access code to be individually deleted, use the programming sequence in 2.5.6.

1. Press * 7 1 and enter the MASTER CODE. [*** 7 1** _ _ _ _ (beep)]
2. Press 2, then press *. [**2 ***(beep)]
3. Enter the five-digit access code to be deleted, then press *. [**_ _ _ _ _ ***(beep)]
See 2.5.1 and/or 2.5.2 for the five-digit access code.
4. Repeat steps 2 and 3 to delete additional existing “simple” and “time zone restricted” access codes.
5. Press 0 # TOGETHER to end. [**0 #** (beeeeeep)]

2.5.4 Delete All Access Codes (Simple and Time Zone Restricted)

This programming sequence **ONLY** deletes **ALL** existing "simple" and "time zone restricted" access codes that have been programmed into the system. "temporary" access codes **CANNOT** be deleted. If you require all "temporary" access codes to be deleted, use the programming sequence in 2.5.7.

WARNING: Once started, all "simple" and "time zone restricted" access codes will be erased.

1. Press * 7 2 and enter the MASTER CODE. [*** 7 2 _ _ _ _ (beep)**]
2. Press 2, then press *. [**2 *(beep)**]
3. Press 9 9 9 9, then press *. [**9 9 9 9 (beep)**]
4. The programming sequence will end itself automatically. [**beeeeeep**]

2.5.5 "Temporary" Access Code Programming

This programming sequence programs up to **10 "temporary" access codes** with a beginning and ending date and any time zone restrictions that may need to be applied.

1. Press * 7 3 and enter the MASTER CODE. [*** 7 3 _ _ _ _ (beep)**]
2. Press 2, then press *. [**2 *(beep)**]
3. Choose and enter a five-digit "temporary" access code, then press *. [**_ _ _ _ _ *(beep)**]
4. Enter the beginning month (01 to 12) and day (01 to 31), then press *. [**_ _ _ _ *(beep)**]
5. Enter the ending month (01 to 12) and day (01 to 31), then press *. [**_ _ _ _ *(beep)**]
6. Enter a minimum of 1, and a maximum of 4 time zones (valid time zones are 0 through 6) that you want to apply to this access code, then press *. [**_ _ _ _ *(beep)**]
Time zone 0 - Always deny access.
Time zone 1 - Allows 24/7 access for relay 1 ONLY.
Time zone 2 - Allows 24/7 access for relay 2 ONLY.
Time zones 3, 4, 5 and 6 - Are time zones that have been programmed in 2.6.6.
7. Enter 0 * for momentary relay activation **OR** enter 1 * to hold open (latch) the relay. [**_ *(beep)**]
8. Repeat steps 2 through 7 to program additional "temporary" access codes.
9. Press 0 # TOGETHER to end. [**0 # (beeeeeep)**]

2.5.6 Delete a "Temporary" Access Code

This programming sequence deletes individual existing "temporary" access codes that have been programmed into the system. "simple" and/or "time zone restricted" access codes **CANNOT** be deleted. If you require "simple" and/or "time zone restricted" access codes to be individually deleted, use the programming sequence in 2.5.3.

1. Press * 7 4 and enter the MASTER CODE. [*** 7 4 _ _ _ _ (beep)**]
2. Press 2, then press *. [**2 *(beep)**]
3. Enter the five-digit "temporary" access code to be deleted, then press *. [**_ _ _ _ _ *(beep)**]
See 2.5.5 for the five-digit "temporary" access code(s).
4. Repeat steps 2 and 3 to delete additional existing "temporary" access codes.
5. Press 0 # TOGETHER to end. [**0 # (beeeeeep)**]

2.5.7 Delete All "Temporary" Access Codes

This programming sequence **ONLY** deletes **ALL** existing "temporary" access codes that have been programmed into the system. "simple" and "time zone restricted" access codes **CANNOT** be deleted. If you require all "simple" and "time zone restricted" access codes to be deleted, use the programming sequence in 2.5.4.

WARNING: Once started, all "temporary" access codes will be erased.

1. Press * 7 5 and enter the MASTER CODE. [*** 7 5 _ _ _ _ (beep)**]
2. Press 9 9 9 9, then press *. [**9 9 9 9 (beep)**]
3. The programming sequence will end itself automatically. [**beeeeeep**]

2.6 Time Functions

2.6.1 Time and Date Calendar Chip Programming

This programming sequence programs the calendar chip in the 1812 system for the current time and date. The calendar chip must be programmed if any of the time related features are going to be used.

Note: The clock / calendar chip in the 1812 Plus will keep time for approximately 48 hours if power to the system is lost or removed. If power is off longer than this, the clock / calendar chip will have to be reprogrammed.

1. Press * 3 3 and enter the MASTER CODE. [*** 3 3** _ _ _ _ (beep)]
2. Enter the current hour (01 to 12) and minutes (01 to 59), then press *. [_ _ _ _ ***(beep)**]
3. Press 0 * for AM **OR** press 1 * for PM. [_ ***(beep)**]
4. Enter the month (01 to 12), day of the month (01 to 31) and the year (00 to 99), then press *. [_ _ _ _ _ ***(beep)**]
5. Enter the day of the week (1-7), then press *. [_ ***(beep)**]
Sun = 1, Mon = 2, Tue = 3, Wed = 4, Thu = 5, Fri = 6, Sat = 7.
6. Press 0 # TOGETHER to end. [**0 # (beeeeeep)**]

Example: Saturday, February 14th, 2010, 11:30 AM.

- Your Master Code - **1. * 3 3** _ _ _ _ (beep)
Time - **2. 1 1 3 0** *(beep)
AM - **3. 0** *(beep)
Date - **4. 0 2 1 4 1 0** *(beep)
Day - **5. 7** *(beep)
End Programming - **6. 0 # TOGETHER (beeeeeep)**

2.6.2 Call Forward Phone Number Programming

These steps program the call forward telephone number into the 1812 memory. Call forward can **only** be used when the 1812 is programmed in **phone mode** (see 2.3.1). To turn ON/OFF or setup a time zone activation for the call forward see 2.6.3.

1. Press * 1 0 and enter the MASTER CODE. [*** 1 0** _ _ _ _ (beep)]
2. Enter the phone number where calls from the 1812 are to be forwarded to (up to 20 digits, no dashes), then press *. [_ _ _ _ _ _ _ _ _ _ ***(beep)**]
All 20 spaces do not have to be populated with numbers.
3. Press 0 # TOGETHER to end. [**0 # (beeeeeep)**]

2.6.3 Call Forward - ON/OFF or Time Zone Activation

This programming sequence turns the call forward feature ON/OFF or setup a time zone activation. You must have a call forward phone number programmed into the 1812 memory (See 2.6.2).

1. Press * 3 7 and enter the MASTER CODE. [*** 3 7 _ _ _ _ (beep)**]
2. Press 0 * to turn call forward OFF, **OR** press 1 * to always call forward, **OR** press 2 * to call forward per the call forward time zone. [**_ *(beep)**]
You can terminate here (Go to step 8 to finish) if you have previously programmed the time zone and only ON / OFF or Call Forward per the time zone is desired.
3. Enter the beginning hour (01 to 12) and minutes (01 to 59), then press *. [**_ _ _ _ *(beep)**]
4. Press 0 * for AM **OR** press 1 * for PM. [**_ *(beep)**]
5. Enter the ending hour (01 to 12) and minutes (01 to 59), then press *. [**_ _ _ _ *(beep)**]
6. Press 0 * for AM **OR** press 1 * for PM. [**_ *(beep)**]
7. Enter the days of the week that the call forward time zone is to be active, then press *. [**_ _ _ _ _ _ _ *(beep)**]
Sun = 1, Mon = 2, Tue = 3, Wed = 4, Thu = 5, Fri = 6, Sat = 7.
You can enter up to 7 numbers here (1-7) but all 7 spaces do not have to be populated with numbers. For example, for the call forward to be active only on Saturdays and Sundays, enter 1 7 *. The order of the numbers is not important; 17 is the same as 71.
8. Press 0 # TOGETHER to end. [**0 # (beeeeeep)**]

2.6.4 Do Not Disturb Time Zone Programming

Factory setting in step 2 is 0 (DND Off).

The Do Not Disturb (DND) feature allows the resident to program a time zone when they do not want the 1812 to ring the house phones or to call forward when the call button on the unit is pressed. For example, a resident may program a do not disturb time zone from 10 PM to 7 AM on certain days of the week, or all seven days. Only one DND time zone can be programmed. Once the DND time zone has been programmed, it can be turned ON or OFF as needed.

1. Press * 3 4 and enter the MASTER CODE. [*** 3 4 _ _ _ _ (beep)**]
2. Press 0 * to turn DND OFF, **OR** press 1 * to turn DND ON. [**_ *(beep)**]
You can terminate here (Go to step 8 to finish) if you have previously programmed the DND time zone and only ON / OFF is desired.
3. Enter the beginning hour (01 to 12) and minutes (01 to 59), then press *. [**_ _ _ _ *(beep)**]
4. Press 0 * for AM **OR** press 1 * for PM. [**_ *(beep)**]
5. Enter the ending hour (01 to 12) and minutes (01 to 59), then press *. [**_ _ _ _ *(beep)**]
6. Press 0 * for AM **OR** press 1 * for PM. [**_ *(beep)**]
7. Enter the days of the week that the DND is to be active, then press *. [**_ _ _ _ _ _ _ *(beep)**]
Sun = 1, Mon = 2, Tue = 3, Wed = 4, Thu = 5, Fri = 6, Sat = 7.
You can enter up to 7 numbers here (1-7) but all 7 spaces do not have to be populated with numbers. For example, for the DND to be active only on Saturdays and Sundays, enter 1 7 *. The order of the numbers is not important; 17 is the same as 71.
8. Press 0 # TOGETHER to end. [**0 # (beeeeeep)**]

2.6.5 Automatic Relay Activation Time Zone Programming (Up to 4)

Factory setting in step 3 is 0 (Time zones are OFF).

This program sequence sets up time zones to automatically activate and deactivate relays. Up to four (4) time zone can be programmed, each of which can be assigned to the desired relay(s). These time zones can be independently turned ON or OFF after they have been programmed.

1. Press * 3 5 and enter the MASTER CODE. [*** 3 5** _ _ _ _ (beep)]
2. Enter a time zone number (1, 2, 3 or 4), then press *. [**_ ***(beep)]
3. Press 0 * to turn the time zone OFF, **OR** press 1 * to turn the time zone ON. [**_ ***(beep)] You can terminate here (Go to step 11 to finish) if you have previously programmed the time zone and only ON / OFF is desired.
4. Enter the beginning hour (01 to 12) and minutes (01 to 59), then press *. [**_ _ _ _ ***(beep)]
5. Press 0 * for AM **OR** press 1 * for PM. [**_ ***(beep)]
6. Enter the ending hour (01 to 12) and minutes (01 to 59), then press *. [**_ _ _ _ ***(beep)]
7. Press 0 * for AM **OR** press 1 * for PM. [**_ ***(beep)]
8. Enter the days of the week that the auto relay time zone is to be active, then press *. [**_ _ _ _ _ _ ***(beep)]
Sun = 1, Mon = 2, Tue = 3, Wed = 4, Thu = 5, Fri = 6, Sat = 7.
You can enter up to 7 numbers here (1-7) but all 7 spaces do not have to be populated with numbers. For example, for the auto relay time zone to be active only on Saturdays and Sundays, enter 1 7 *. The order of the numbers is not important; 17 is the same as 71.
9. Enter the relay number(s) that the time zone will apply to, then press *. [**_ _ ***(beep)]
You can enter a single relay number (1 or 2) or both relay numbers (1 and 2 together - 12).
10. Repeat steps 2 through 9 to program the other time zones (up to 4).
11. Press 0 # TOGETHER to end. [**0 # (beeeeeep)**]

2.6.6 Access Code Time Zone Programming (Up to 4)

Factory setting in step 3 is 0 (Time Zones are OFF).

This programming sequence sets up time zones (up to 4) that can be applied to the "Access Code Programming (Time Zone Restricted)" programmed in section 2.5.2 into the 1812. These time zones can be turned ON or OFF once they have been programmed.

1. Press * 3 6 and enter the MASTER CODE. [*** 3 6** _ _ _ _ (beep)]
2. Enter a time zone number (3, 4, 5 or 6), then press *. [**_ ***(beep)]
Do not use 0, 1 or 2 for time zone numbers. These are already used; **0** = always deny,
1 = 24/7 access for Relay 1 ONLY ; **2** = 24/7 access for Relay 2 ONLY.
3. Press 0 * to turn the time zone OFF, **OR** press 1 * to turn the time zone ON. [**_ ***(beep)]
You can terminate here (Go to step 11 to finish) if you have previously programmed the time zone schedule and only ON / OFF is desired.
4. Enter the beginning hour (01 to 12) and minutes (01 to 59), then press *. [**_ _ _ _ ***(beep)]
5. Press 0 * for AM **OR** press 1 * for PM. [**_ ***(beep)]
6. Enter the ending hour (01 to 12) and minutes (01 to 59), then press *. [**_ _ _ _ ***(beep)]
7. Press 0 * for AM **OR** press 1 * for PM. [**_ ***(beep)]
8. Enter the days of the week that the time zone is to be active, then press *. [**_ _ _ _ _ _ ***(beep)]
Sun = 1, Mon = 2, Tue = 3, Wed = 4, Thu = 5, Fri = 6, Sat = 7.
You can enter up to 7 numbers here (1-7) but all 7 spaces do not have to be populated with numbers. For example, for the time zone to be active only on Saturdays and Sundays, enter 1 7 *. The order of the numbers is not important; 17 is the same as 71.
9. Enter the relay number(s) that the time zone will apply to, then press *. [**_ _ ***(beep)]
You can enter a single relay number (1 or 2) or both relay numbers (1 and 2 together - 12).
10. Repeat steps 2 through 9 to program the other time zones (up to 4).
11. Press 0 # TOGETHER to end. [**0 # (beeeeeep)**]

2.7 Miscellaneous

2.7.1 Restore Factory Settings

This step will restore the factory settings for each of the programming parameters. See the “Quick Reference Table” on page 22 for all of the factory settings. The master code will remain intact after the factory settings have been restored.

WARNING: Once started, this sequence will program ALL values to factory default.

1. Press * 9 0 and enter the MASTER CODE. [*** 9 0 _ _ _ _ (beep)**]
2. Press 9 9 9 9, then press *. [**9 9 9 9 (beep)**]
3. The programming sequence will end itself automatically. [**beeeeeep**]

SECTION 3 - ADJUSTMENTS

Speaker Volume

The speaker volume potentiometer is labeled SPEAKER VOL on the control board. The speaker volume should be adjusted for adequate sound. Adjusting the speaker volume too loud could cause feedback from the microphone.

1. Open the front of the telephone entry system and locate the speaker volume adjustment.
2. Push the "Push To Call" button to place a call to the resident. While they are talking, adjust the speaker volume potentiometer for adequate sound. To increase the volume rotate the potentiometer clockwise, to decrease the volume rotate the potentiometer counter clockwise.

Microphone Gain

The microphone gain potentiometer is labeled MIC VOL on the control board. This adjustment increases or decreases the loudness in the telephone handset in the house.

1. Open the front of the telephone entry system and locate the Mic Vol adjustment.
2. Push the "Push To Call" button to place a call to the resident. After they answer, adjust the microphone gain and ask the resident to let you know when the loudness in their telephone handset is set to a comfortable level.

Interface Board LED Status

Phone Line In Use - Yellow LED indicates that the phone line is being used (dial-out, call forwarding, etc.).

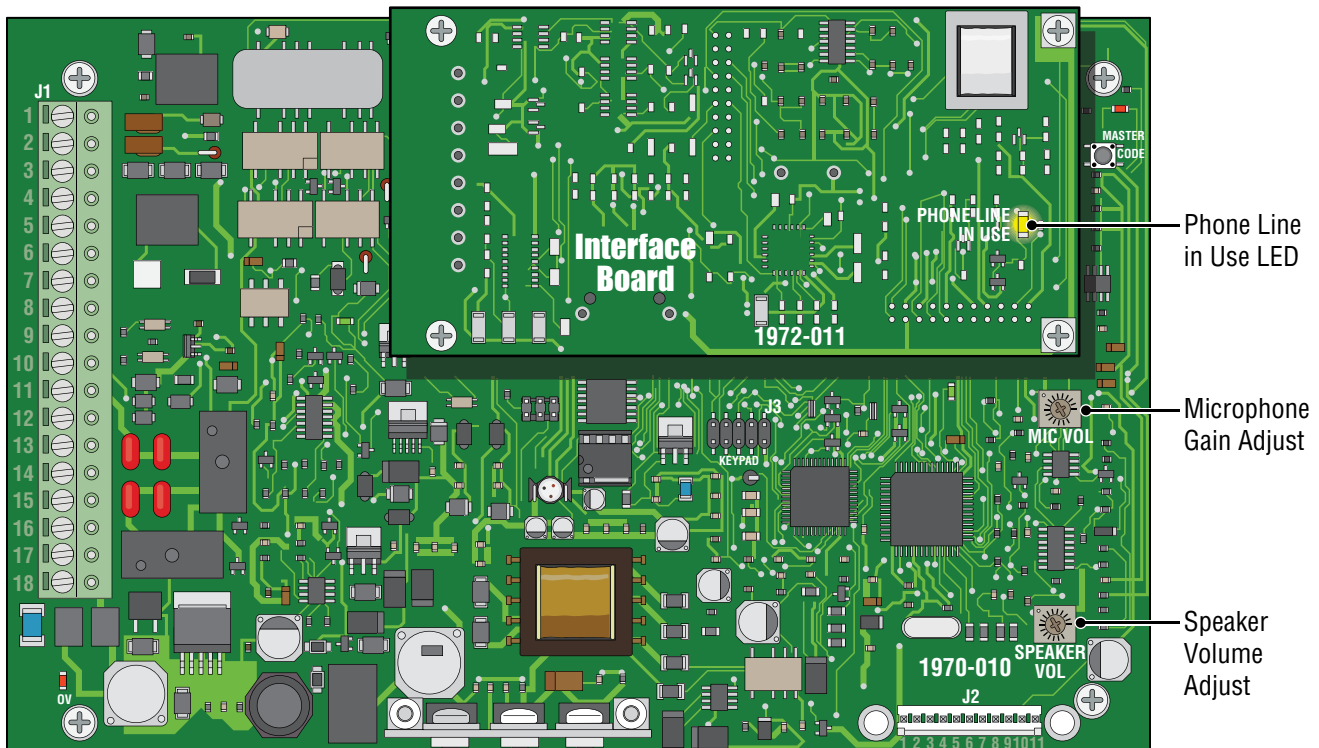

System Keypad

Used to key in existing Access Codes and Directory Codes during normal operation. Also used to program the system features.

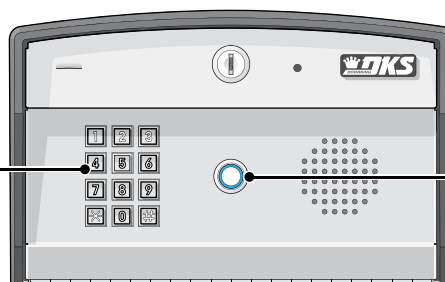

Push To Call Button

Places a call from the 1812 to the resident's house.

SECTION 4 - USER INSTRUCTIONS

4.1 Resident Operating Instructions

4.1.1 Granting or Denying a Guest Access

To place a call from the 1812 to the resident's house, the guest simply presses the PUSH TO CALL button located on the faceplate, see previous page. Once the guest has been identified by voice communication, the resident may grant them access by pressing the appropriate tone open number, or they may deny access by simply hanging up.

1. To grant access to a guest, press the programmed tone open number. (The factory setting for the tone open number is 9, however this can be programmed to any number desired. See section 2.3.8 to program tone open numbers.) The 1812 will respond with a confirming tone and will open the door or gate.
2. To deny access, hang up the telephone.

Prior to ringing the resident's phones, the 1812 will perform several logic steps to check the status of the Do Not Disturb (DND) and Call Forward features.

If the DND feature is turned on, the DND time zone will be checked. If the current time is within the DND time zone, the system will not ring the resident's phones or call forward.

If the call forward feature is turned off, the 1812 will always ring the resident phones when the Push To Call button is pressed. If the call forward feature is turned on and the current time does not fall within the call forward time zone boundaries, the system will ring the resident's phone when Push To Call is pressed. If the call forward time zone is turned on and the current time is within the call forward time zone boundaries, the system will dial the preprogrammed call forward phone number.

4.1.2 Call Waiting

When the resident is on their telephone and a guest pushes the Push To Call push button, the 1812 will sound a short tone in the resident's handset. This indicates to the resident that a guest is at their door or gate.

1. To place the outside call on HOLD and talk to the guest, press #.
2. To grant the guest access, press the programmed tone open number. The 1812 will respond with a confirming tone, open the door or gate, and will reconnect the resident's phone with their outside call.
3. To deny the guest access, press #. The 1812 will disconnect from the resident's phone and reconnect it to the outside call.

The same process can be used when the resident is talking to a guest at the 1812 and an outside call comes in. The resident can place the guest on hold and switch to the outside call.

4.1.3 Dial-Out Phone Numbers

To use the dial-out phone number feature, the guest simply presses a two-digit directory code (24-50) on the system keypad. The 1812 will automatically dial out the phone number programmed under the directory code that was entered on the keypad (section 2.4.1). Once the call is answered, the person called may grant access by pressing the programmed tone open number or they can press the hang up number (2.3.10) to disconnect the call without granting access.

4.1.4 Access Codes

"simple" access codes (five-digit entry code on the 1812 keypad) will operate either relay depending on which relay has been programmed to activate on a 24/7 basis (2.5.1). "time zone restricted" (2.5.2) or "temporary" (2.5.5) access codes will operate either relay that they have been programmed to operate.

To use a keypad access code:

1. Press # then enter the access code (Five-Digits). [# _ _ _ _ _ (beep)]

When the access code is entered on the keypad, the system will check its memory to see if the code is programmed and will also check any "time zone restrictions" that may have been programmed for the specific code that was entered.

If the access code is a "temporary" code, the system will check the clock/calendar to determine if the current day falls within the programmed "temporary" access code boundaries (section 2.5.5).

4.2 Remote Operation

4.2.1 Remote Programming (Home Phone or Off-Site Phone)

The 1812 can be programmed and operated from a remote location (Home or off-site) using a touch-tone telephone. Be sure that the programming for the 1812 to answer an incoming call has not been disabled (see 2.3.9).

Note: The 1812 master code cannot be programmed remotely – it can only be programmed from the system keypad – see Programming the Master Code on page 20.

1. Call the resident's phone number. After the programmed number of rings (2.3.9) the 1812 will answer with a tone.
2. Follow the desired programming steps in Section 2 of this manual.
3. When complete with the desired programming function, hang up. You cannot use 0# pressed together to end programming steps from a touch-tone telephone. Wait 30 seconds before calling back to program another feature.

4.2.2 Remote Relay Activation (Off-Site Phone)

The 1812 system relays can be activated from a remote (off-site) location. Be sure that the ability for the 1812 to answer an incoming call has not been disabled (see 2.3.9). Refer to the tone open numbers that were programmed in section 2.3.8 to determine each of the activation numbers. Only one activation number will function per phone call. Example: If you call and want to "Hold Open" the relay, you will have to call back to "Deactivate" it later.

- **Momentary Activation** (Relay activates for its programmed relay strike time).
- **Hold Open** (Relay will activate and remain activated).
- **Deactivate** (Relay will deactivate).
- **Hold 1 Hour** (Relay will activate for 1 hour and then automatically deactivate).

To activate the relay(s) from a remote (off-site) location, perform the following steps:

1. Call the resident's phone number. After the programmed number of rings (2.3.9) the 1812 will answer with a tone.
2. Press * 1 6 and enter the MASTER CODE. [* 1 6 _ _ _ _ (beep)]
(Two-way voice communication is also enabled at this point)
3. Enter the desired tone open number. [_ (beep)]
4. 1812 will automatically hang up.

4.2.3 Relay Activation from Homeowner's Phone

The 1812 system relays can be activated from the homeowner's phone. Refer to the tone open numbers that were programmed in section 2.3.8 to determine each of the activation numbers. Only one activation number will function per phone call. Example: If you call and want to "Hold Open" the relay, you will have to call back to "Deactivate" it later.

- **Momentary Activation** (Relay activates for its programmed strike time).
- **Hold Open** (Relay will activate and remain activated).
- **Deactivate** (Relay will deactivate).
- **Hold 1 Hour** (Relay will activate for 1 hour and then automatically deactivate).

To activate the relay(s) from the resident's house, perform the following steps:

1. Pick up your telephone and press * 7. [* 7 (beep)]
2. Enter the desired tone open number (2.3.8). [_ (beep)]
3. 1812 will automatically hang up.

4.2.4 Relay Activation Check from Homeowner's Phone

The 1812 can be called to check if relay 1, relay 2, or both relays on the 1812 main circuit board are latched and holding a door or gate in the open (unlocked) position.

1. Pick up homeowner's telephone and press * 7. [* 7 (beep)]
2. Listen for the following sequence of tones:
No Tones: neither relay is activated.
Relay 1 Activated: beep - pause - beep - pause . . .
Relay 2 Activated: beep beep - pause - beep beep - pause . . .
Both Relays Activated: beep beep beep - pause - beep beep beep - pause . . .
3. Hang up.

4.2.5 Initiate Talk and Listen to 1812 when it has not been activated

The homeowner's phone can establish direct communication to the 1812 (Talk and listen from the phone) without the 1812 being activated first (Typically a guest pressing the call button at the 1812 will activate it). This is useful when a normal telephone entry system transaction does not occur and the homeowner must initiate communication to the 1812 to talk and listen from it.

1. Pick up homeowner's telephone and press * 7. [* 7 (beep)]
2. Talk and/or listen from homeowner's phone.
3. Hang up when finished.

SECTION 5 - MAINTENANCE

The DoorKing 1812 telephone entry system is essentially a maintenance free device. When the unit is properly installed, it should provide years of trouble free service. Maintenance is limited to updating the access codes and temporary access codes on an as needed basis.

The faceplate of the unit should be cleaned on a regular basis to keep contaminants in the air from sticking to the surface and possibly causing pitting. When cleaning the faceplate of the system, never use an abrasive cleaner or cloth. Stainless steel cleaner works very well with a soft cloth for systems with a stainless steel faceplate. A clean damp soft cloth should be used to clean gold plated faceplates.

5.1 Troubleshooting

If problems should develop with your telephone entry system, refer to 5.4 troubleshooting table on pages 37 and 38 to try and correct any problems. Our experience has shown that a majority of reported problems are actually programming related and can be corrected on site. If problems persist and they cannot be corrected, contact your authorized DoorKing dealer for assistance. Before performing any troubleshooting, check the following:

1. Have a good VOM meter handy to check voltages and continuity.
2. Have a telephone test set (DoorKing P/N 1800-050 or equivalent) to check the telephone line. Noise on the phone line will cause problems with the entry system.
3. Check the polarity of the phone lines. See section 5.2 on the next page.
4. Be sure that the entry system case is properly grounded.
5. Be sure that the telephone wires are twisted.
6. A hum on the system indicates that the phone line or 16.5 VAC power lines may be grounded. Check to be sure that the phone lines or power lines are not shorted to ground. Be sure that the cable used for communication is a twisted pair, good quality phone cable insulated for direct underground burial. **Using phone wire that is designed for indoor use only can absorb moisture and cause a hum on your phone line.**
7. Check the 16.5 VAC system power. Be sure that the transformer is properly rated (20 VA). **DO NOT USE 24 VAC POWER.** Keep the wire run from the transformer to the entry system as short as possible. Use 16 or 18 AWG, 600 volt insulated wire only. **The importance of proper power wiring cannot be over stressed!**

5.2 Phone Line Polarity

When troubleshooting 1812 operational problems, check phone line polarity. **Crossed polarities can affect system operation.**

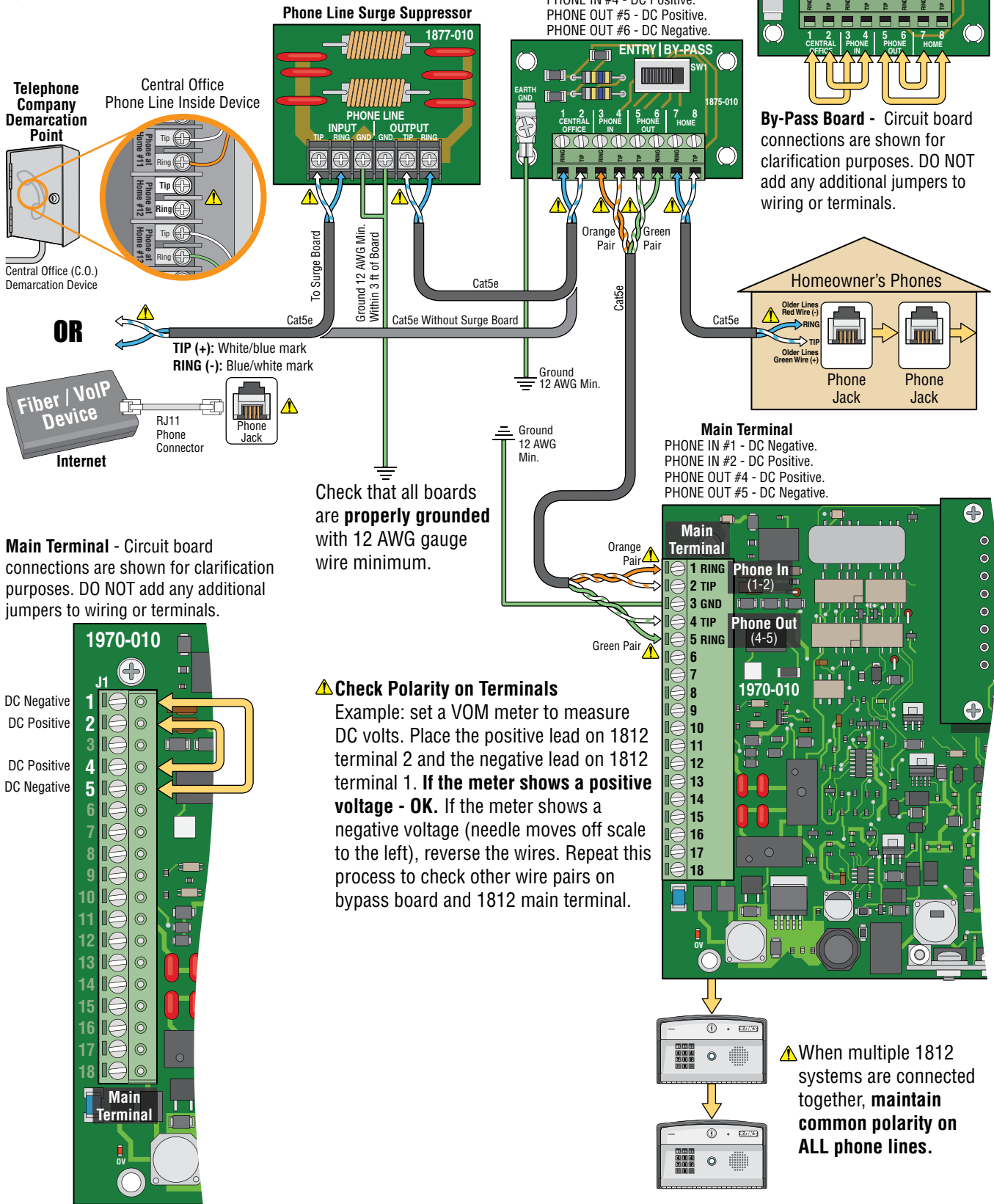

5.3 Isolating Noise Problems

If noise or hum is present on the resident's phone line after installation of the 1812 telephone intercom system, use the procedure on the next page to find and correct the source of the noise. This procedure will require the use of a telephone test set (DoorKing P/N 1800-050 or equivalent). Typically, noise is usually introduced into the system because of incorrect wiring, poor quality of wire, wire runs exceeding maximum distances, phone and high voltage power wires running in the same conduit or in very close proximity to each other, a wrong type transformer was substituted, or the phone lines, power lines or 1812 circuit board is grounded.

1. Place the BYPASS switch in the BYPASS mode (slide switch to right). If noise goes away, problem is with phone in/out wiring, power wiring, or 1812 unit. Place the BYPASS switch in the ENTRY SYSTEM mode (slide switch to left) and proceed to step 3. If noise is still present when switch is in the bypass mode, disconnect C.O. wires and HOUSE wires from bypass switch. Connect the C.O. wires to the HOUSE wires. If the noise goes away, the bypass switch is bad and needs to be replaced. If noise is still present, contact the telephone company for service.
2. Remove all external items connected to the 1812 unit, such as back-up batteries, relay connections, push button switches, or time clocks. All terminals should be free of any wiring except terminals 1 and 2 (PHONE IN WIRES), terminal 3 (CASE GROUND WIRE), terminals 4 and 5 (PHONE OUT WIRES), and terminals 17 and 18 (16.5 VAC POWER WIRES). If noise is still present, proceed to step 3. If noise is gone, the source of the noise is one of the external devices that were connected to the 1812. Reconnect them one at a time until you find the item that is the source of the noise.
3. Remove the PHONE OUT wires from terminals 4 and 5 at the 1812 unit. Connect your handy phone directly to the loose PHONE OUT wires. The wires should be dead and you should not have any dial tone on these wires. If you do have dial tone, the 1812 is wired incorrectly. Disconnect power immediately and refer to the wiring information section in this manual.
4. Disconnect your handy phone from the PHONE OUT wires (step 3). Remove the PHONE IN wires from terminals 1 and 2 at the 1812 unit. Connect the PHONE IN wires to the PHONE OUT wires. This completely disconnects the 1812 unit from the circuit. Check the phones in the house. If the noise is gone, problem is with or in the 1812 unit, or with the power supply or power wiring. Reconnect the PHONE IN wires to terminals 1 and 2, and the PHONE OUT wires to terminals 4 and 5, then proceed to step 5. If the noise is still present, problem is with the PHONE IN or PHONE OUT wires running from the 1812 unit to the bypass switch. These wires will need to be replaced and/or re-routed to correct the problem.
5. Disconnect the 24 VAC wires from terminals 17 and 18. If the phone line is now clear, the problem is in the 24 VAC power run. Check the power lines for a ground, or running next to high voltage wires, or an improper wire size and insulation, or too long of a wire run. If noise is still present, go to step 6.
6. If noise is still present at this step in the trouble shooting sequence, this would indicate a short to ground internally in the 1812 unit. Remove CN2 8-pin door accessories plug from the circuit board, and check for noise again. If noise is gone, this would indicate a problem with the microphone board, speaker, push button, or lights on the front panel assembly. Check for any shorts to ground on any of these components or wiring. Check to be sure that none of the wires are pinched. If noise is still present, check the wires entering the back of the 1812 box and be sure that none are pinched. Be sure that these wires are not touching the back of the 1812 circuit board, possibly causing a short to ground. If all of the above steps fail to identify the source of noise, contact DoorKing for additional assistance.

5.4 Troubleshooting Table

Symptom	Possible Solution(s)
Cannot get into programming mode.	<ul style="list-style-type: none"> • Wrong master code entered. Start over. • Waiting too long between pushing buttons. Enter information quicker. • Keypad is not plugged into board correctly. Cable points down (See page 40, Red wire on the left).
System emits a long tone and cancels programming.	<ul style="list-style-type: none"> • Waiting too long between pushing buttons. • Forgetting to press * first when programming.
OV LED is ON. Nothing operates.	<ul style="list-style-type: none"> • Too much input power. "OV" (Over Voltage) LED will be ON when too much power (24 VAC) is applied to circuit board. Check for 16.5 VAC input power maximum (DO NOT use 24 VAC input power).
Keypad is dead.	<ul style="list-style-type: none"> • No power. Check for 16.5 VAC input power maximum (DO NOT use 24 VAC input power). • Too much power. "OV" LED will be ON when too much power (24 VAC) is applied to circuit board. • Check that the keypad is properly connected to the circuit board. The cable on the plug points down when connected to the circuit board (See wiring schematics on page 40 for correct keypad connection).

Symptom	Possible Solution(s)
Dial tone is heard on the 1812 speaker.	<ul style="list-style-type: none"> The system is not wired in series with the resident phone line. Check the PHONE IN terminals (1 & 2) and the PHONE OUT terminals (4 & 5).
Buzz or noise on the line.	<ul style="list-style-type: none"> Check for a short to ground behind the circuit board. Check for pinched wires near the door hinge. Check for 16-volt power shorted to a conduit. Check for a phone line shorted to ground. Check that the phone wires are twisted. Check that all wires, speaker, keypad, etc., are isolated from ground. Check that the cabinet is properly grounded. Be sure case ground (terminal 3) is not used as a low voltage common. Check for excessive voltage drop on 16 VAC power. Check phone line with telephone test set.
Buzz on telephone line.	<ul style="list-style-type: none"> Remove the PHONE IN and PHONE OUT wires from the 1812 terminal strip. Connect the PHONE IN wires to the PHONE OUT wires. If the noise is still present, bad PHONE IN or PHONE OUT wires. Remove 16.5 VAC wires from the terminal strip. Check house phones. If noise goes away, 16.5 VAC wires are probably grounded. Replace wires. Check internal wires, switch wires, battery wires for any pinches or shorts.
Phones in home will not ring.	<ul style="list-style-type: none"> Check that the by-pass switch is not set to by-pass mode. Do Not Disturb time zone may be enabled. Turn Do Not Disturb off or change time zone boundaries. Call forward feature enabled or call forward time zone is turned on. Turn off call forward and call forward time zone. Change call forward time zone boundaries. Voltage drop in 16 VAC supply. Check voltage at terminals 17 & 18. Disconnect PHON OUT wires from terminals 4 & 5. Connect test telephone to terminals 4 & 5. If test telephone rings, problem is with phone out wiring. If test phone does not ring, circuit board may be at fault.
Phones in home ring, but no communication occurs.	<ul style="list-style-type: none"> Check telephone company demarcation (interface) device placement. 1812 must be wired so that the C.O. wires exiting the demarcation device are connected to the C.O. terminals on the bypass switch. Check the wiring diagram. Disconnect the PHONE OUT wires and connect a test telephone to the PHONE OUT terminals (4 & 5). If the 1812 cannot communicate with the test phone, PHONE IN and PHONE OUT wires may be connected backwards. Check wiring and reconnect.
System will not activate relays. Phones do not generate a tone.	<ul style="list-style-type: none"> Switch the wires on the PHONE OUT terminals (4 & 5). Switch wires on PHONE IN terminals (1 & 2) if using the call forward or preprogrammed dialing out features.
System generates tone when granting access to a visitor, but will not work on regular phone line.	<ul style="list-style-type: none"> Switch the wires on the PHONE IN terminals.
System will not answer when called from the resident's phone.	<ul style="list-style-type: none"> Using the wrong attention number. Re-program attention number (2.3.3).
System will not answer when called from a remote location.	<ul style="list-style-type: none"> Answer incoming call feature is disabled. Turn answer incoming call feature on (# of rings 2.3.9). Number of rings to answer may be programmed too high. Reprogram number of rings to answer.
Electric strike locks on or gate operator holds open.	<ul style="list-style-type: none"> Excessive voltage drop on 16.5 VAC line. Auto relay activation time zone is enabled. Turn off auto relay time zone or reprogram the time zone. Access code used was programmed under a hold open relay code. Reprogram access code into a momentary activation relay code (2.5.2). A hold command was sent to the relay from the resident's phone. Deactivate the relay using the resident's phone.
Access code will not work.	<ul style="list-style-type: none"> Forgetting to press # first. Access code is time zone restricted and the access code time zone is enabled. Turn access code time zone off, reprogram time zone boundaries or reprogram "simple" access code without a time zone.

5.5 Wiring Schematic

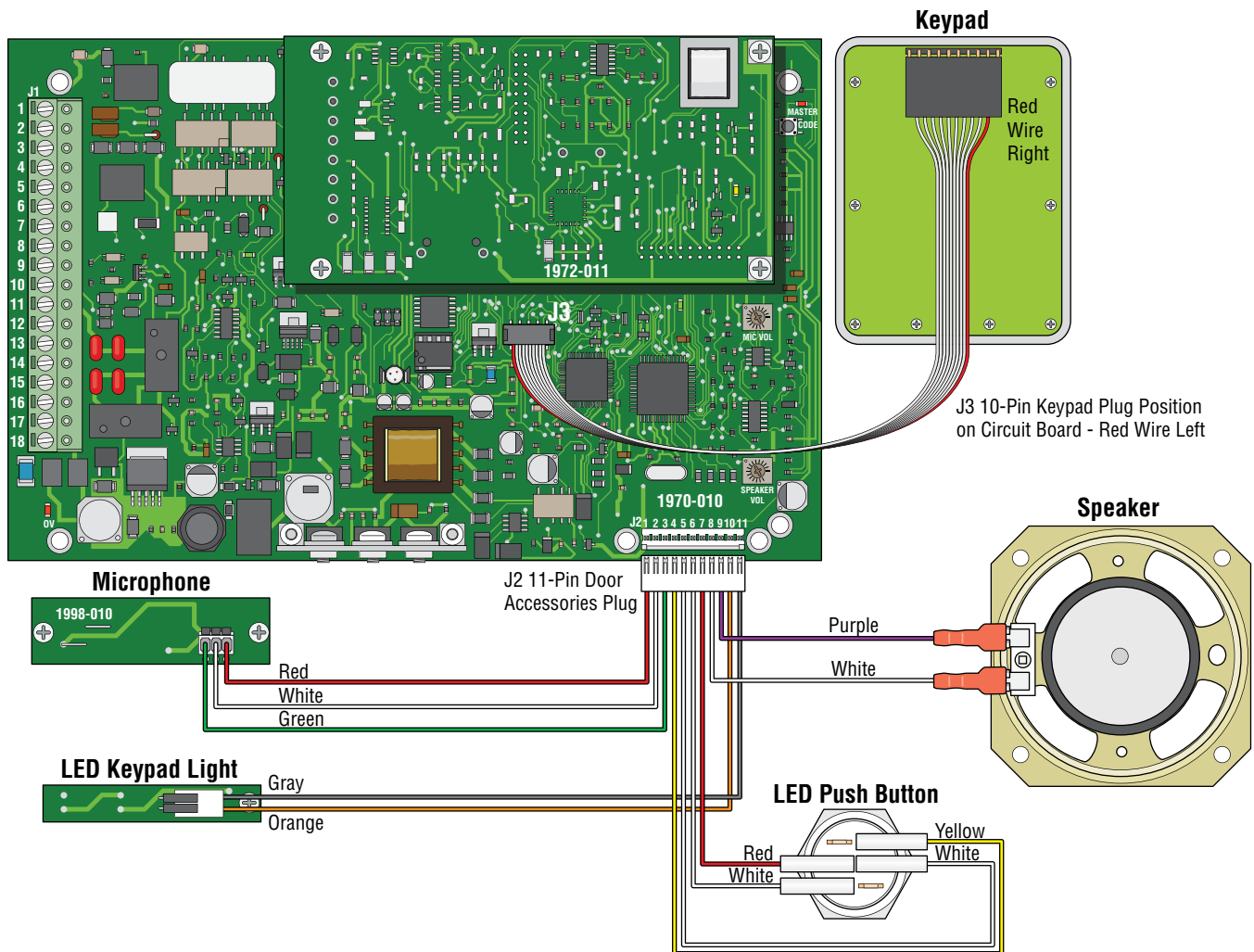

5.6 Accessories

Secondary Keypads: Allows remote activation of the system relays by use of the access codes. Does not provide any voice communication to the main unit or to the resident telephone. P/N 1812-082 (surface mount); P/N 1812-197 (flush mount)

Surge Suppressors:

High voltage (115 V) suppressor. P/N 1876-010.

Phone line suppressor. P/N 1877-010.

Low voltage (28 V) suppressor. P/N 1878-010.

Mounting Posts:

Gooseneck mounting post with concrete base plate. P/N 1200-045.

Gooseneck mounting post – direct burial. P/N 1200-046.

Telephone Test Set: Includes clips, cord and carrying case. P/N 1800-050.

Back-Up Battery: 12 volt .8 amp hour gel cell provides stand by power during power interruptions. P/N 1801-008.

Postal Lock Box: Provides a means for the mail carrier to enter the premise to deliver mail. P/N 1402-080.

Magnetic Locks: A variety of magnetic locks are available to meet individual application requirements. Contact your DoorKing dealer.

Electric Strikes: A variety of electric strikes are available to meet individual application requirements. Contact your DoorKing dealer.

CCTV Camera: Camera mounted in phone system. P/N 1812-130 Color, P/N 1812-040 Black & White. Not available for the wall mount model.

5.7 Programmed Information Log Sheets

Complete the information in the tables on the following pages to maintain a record of the information that has been programmed into the 1812 Plus entry system. 1812 Plus manual is available on-line at: www.dkaccess.com if extra log sheets are required.

Master Code			
1st Digit	2nd Digit	3rd Digit	4th Digit

Tone Number Function	Relay	
	1	2
Momentary Activation		
Hold Open		
Deactivate Relay		
Hold Open 1 Hr.		

Do Not Disturb Time Zone	
Beginning Time	
Ending Time	
Days of the Week	

Call Forward Time Zone	
Beginning Time	
Ending Time	
Days of the Week	

	Access Code Time Zones			
	Time Zone 1	Time Zone 2	Time Zone 3	Time Zone 4
Beginning Time				
Ending Time				
Days of the Week				
Relays				

	Automatic Relay Activation Time Zones			
	Time Zone 1	Time Zone 2	Time Zone 3	Time Zone 4
Beginning Time				
Ending Time				
Days of the Week				
Relays				

Directory Codes 24 – 50 / Dial-Out Phone Numbers

Directory Code	Name	Phone Number
24		
25		
26		
27		
28		
29		
30		
31		
32		
33		
34		
35		
36		
37		
38		
39		
40		
41		
42		
43		
44		
45		
46		
47		
48		
49		
50		

1-25 Access Codes Log Sheet (With Phone Numbers)

Name / Phone Number (Optional)	Access Code # and Type: Simple or Time Zone Restricted	Time Zone Restricted Information	
		Time Zone Number	Relay: Momentary or Hold (Latch)
1			
2			
3			
4			
5			
6			
7			
8			
9			
10			
11			
12			
13			
14			
15			
16			
17			
18			
19			
20			
21			
22			
23			
24			
25			

26-50 Access Codes Log Sheet (With Phone Numbers)

Name / Phone Number (Optional)	Access Code # and Type: Simple or Time Zone Restricted	Time Zone Restricted Information	
		Time Zone Number	Relay: Momentary or Hold (Latch)
26			
27			
28			
29			
30			
31			
32			
33			
34			
35			
36			
37			
38			
39			
40			
41			
42			
43			
44			
45			
46			
47			
48			
49			
50			

1-25 Access Codes Log Sheet (Access Only)

Name	Access Code # and Type: Simple or Time Zone Restricted	Time Zone Restricted Information	
		Time Zone Number	Relay: Momentary or Hold (Latch)
1			
2			
3			
4			
5			
6			
7			
8			
9			
10			
11			
12			
13			
14			
15			
16			
17			
18			
19			
20			
21			
22			
23			
24			
25			

26-50 Access Codes Log Sheet (Access Only)

Name	Access Code # and Type: Simple or Time Zone Restricted	Time Zone Restricted Information	
		Time Zone Number	Relay: Momentary or Hold (Latch)
26			
27			
28			
29			
30			
31			
32			
33			
34			
35			
36			
37			
38			
39			
40			
41			
42			
43			
44			
45			
46			
47			
48			
49			
50			

1-10 Temporary Access Codes Log Sheet

Name	Temporary Access Code #	Beginning Date	Ending Date	Time Zone Number	Relay: Momentary or Hold (Latch)
1					
2					
3					
4					
5					
6					
7					
8					
9					
10					

1-10 Temporary Access Codes Log Sheet extra log sheet

Name	Temporary Access Code #	Beginning Date	Ending Date	Time Zone Number	Relay: Momentary or Hold (Latch)
1					
2					
3					
4					
5					
6					
7					
8					
9					
10					

